

WSF VASHON TEST PILE PROJECT

**UNDERWATER SOUND LEVELS
ASSOCIATED WITH DRIVING STEEL
PILES AT THE VASHON FERRY
TERMINAL**



*Prepared by:
Jim Laughlin
Washington State Department of Transportation
Office of Air Quality and Noise
15700 Dayton Avenue North, P.O. Box 330310
Seattle, WA 98133-9710*

April 2010

Table of Contents

List of Tables	ii
List of Figures	ii
<i>Executive Summary</i>	<i>1</i>
<i>Introduction</i>	<i>2</i>
Project Description	2
<i>Underwater Sound Levels</i>	<i>4</i>
Characteristics of Underwater Sound	4
<i>Methodology</i>	<i>5</i>
Temporary Noise Attenuation Pile (TNAP) Design	9
<i>Results</i>	<i>11</i>
Underwater Sound Levels	11
<i>Conclusions</i>	<i>39</i>
<i>References</i>	<i>40</i>
<i>Appendix A– Steel Pile Waveform Analysis Figures</i>	<i>41</i>
Pile P-14 – No Mitigation	41
Pile P-14 – With Mitigation	42
Pile P-14 – With Mitigation + Bubbles	44
Pile P-10 – With Mitigation + Bubbles	45
Pile P-16 – Unmitigated + 24 hrs	46
Pile P-16 – Mitigation and Mitigation +Bubbles	47
Pile P-16 – Mitigation +Bubbles after 24 hrs	49
Pile P-8 Unmitigated	50
Pile P-8 - Mitigated	51
<i>Appendix B– Steel Pile Waveform Analysis Figures from the AMAR Mini</i>	<i>52</i>
Pile P-14 - Mitigated	52
Pile P-14 - Mitigated + Bubbles	53
Pile P-14 - Unmitigated	54
Pile P-10 – Mitigated with Bubbles	55
Pile P-16 – Mitigated	56
Pile P-16 – Mitigated + Bubbles	57
Pile P-16 – Unmitigated + 24 hr	58
Pile P-8 – Mitigated with Bubbles	59
Pile P-8 – Unmitigated	60
<i>Appendix C– Pile Driving Log</i>	<i>61</i>

LIST OF TABLES

Table 1: Summary Table of Monitoring Results.	1
Table 2: Summary of Underwater Sound Levels for the Vashon Test Pile Project, Steel Piles.	14
Table 3: Summary of Underwater Sound Levels from the AMAR Mini for the Vashon Test Pile Project, Steel Piles.	21
Table 4: Comparison of different spreading models using actual measured data.	22
Table 5: Hourly average background RMS values for the Vashon ferry terminal.	37

LIST OF FIGURES

Figure 1: Location of Vashon Test Pile Project at the Vashon ferry terminal.	2
Figure 2: Approximate location of test piles and hydrophone at the Vashon ferry terminal.	3
Figure 3: Near field acoustical monitoring equipment	5
Figure 4: AMAR	6
Figure 5: Acoustical release for AMAR	6
Figure 6: Diagram of hydrophone deployment configuration.	8
Figure 7: Diagram of AMAR deployment configuration	9
Figure 8: Modified Double Walled TNAP Schematics from the University of Washington Applied Physics Laboratory.	10
Figure 9: Waveforms and frequency spectral analysis for Pile P-14 using TNAP.	11
Figure 10: Waveforms and frequency spectral analysis for Pile P-14 using TNAP + Bubbles.	13
Figure 11: Waveforms and frequency spectral analysis for pile P-16 using TNAP2.	17
Figure 12: Waveforms and frequency spectral analysis for pile P-8 using the TNAP.	18
Figure 13: Locations of AMAR deployment relative to the nearfield impact monitoring location at Vashon Ferry Terminal.	20
Figure 14: Pile P-14 (bottom) - Comparison of unmitigated Root Mean Square values (RMS) for individual hammer strikes at 7 meters (near field) and 754 meters (far field) from the pile. Average background RMS values are also included.	23
Figure 15: Pile P-14 (bottom) - Comparison of mitigated Root Mean Square values (RMS) for individual hammer strikes at 7 meters (near field) and 754 meters (far field) from the pile. Average background RMS values are also included.	24
Figure 16: Pile P-14 (bottom) - Comparison of mitigated with bubbles Root Mean Square Values (RMS) for individual hammer strikes at 7 meters (near field) and 754 meters (far field) from the pile. Average background RMS values are also included.	25
Figure 17: Pile P-10 (bottom) - Comparison of mitigated with bubbles Root Mean Square values (RMS) for individual hammer strikes at 11 meters (near field) and 754 meters (far field) from the pile. Average background RMS values are also included.	26
Figure 18: Pile P-16 (bottom) - Comparison of mitigated Root Mean Square values (RMS) for individual hammer strikes at 15 meters (near field) and 754 meters (far field) from the pile. Average background RMS values are also included.	27
Figure 19: Pile P-16 (bottom) - Comparison of mitigated with bubbles Root Mean Square values (RMS) for individual hammer strikes at 15 meters (near field) and 754 meters (far field) from the pile. Average background RMS values are also included.	28
Figure 20: Pile P-16 (bottom) - Comparison of mitigated with bubbles Root Mean Square values (RMS) for individual hammer strikes at 15 meters (near field) and 754 meters (far field) from the pile after a 24-hour period. Average background RMS values are also included.	29
Figure 21: Pile P-16 (midwater) - Comparison of mitigated Root Mean Square values (RMS) for individual hammer strikes at 15 meters (near field) and 754 meters (far field) from the pile after a 24-hour period. Average background RMS values are also included.	30
Figure 22: Pile P-16 (midwater) - Comparison of unmitigated Root Mean Square values (RMS) for individual hammer strikes at 15 meters (near field) and 754 meters (far field) from the pile. Average Background RMS values are also included.	31

Figure 23: Pile P-16 (bottom) - Comparison of unmitigated Root Mean Square values (RMS) for individual hammer strikes at 15 meters (near field) and 754 meters (far field) from the pile. Average Background RMS values are also included.	32
Figure 24: Pile P-8 (bottom) - Comparison of unmitigated Root Mean Square values (RMS) for individual hammer strikes at 16 meters (near field) and 754 meters (far field) from the pile. Average background RMS values are also included.	33
Figure 25: Pile P-8 (midwater) - Comparison of unmitigated Root Mean Square values (RMS) for individual hammer strikes at 16 meters (near field) and 754 meters (far field) from the pile. Average background RMS values are also included.	33
Figure 26: Pile P-8 (bottom) - Comparison of mitigated Root Mean Square values (RMS) for individual hammer strikes at 16 meters (near field) and 754 meters (far field) from the pile. Average background RMS values are also included.	34
Figure 27: Graphical representation of attenuation of the 195 dB RMS value at the source and at what distance it would attenuate to background using the practical spreading model at the Vashon Ferry Terminal.	35
Figure 28: Graphical representation of attenuation of the 195 dB RMS value at the source and at what distance it would attenuate to background using the spherical spreading model at the Vashon Ferry Terminal.	36
Figure 29: Graphical representation of hourly background noise levels (dB RMS) measured for a 24-hour period at the Vashon ferry terminal.	38
Figure 30: Waveform Analysis of Pile P-14 Sound Pressure Levels without mitigation, 3 feet from the bottom (no data for midwater hydrophone).	41
Figure 31: Waveform Analysis of Pile P-14 Sound Pressure Levels with mitigation 1 meter from the bottom (a) and midwater (b).	43
Figure 32: Waveform Analysis of Pile P-14 Sound Pressure Levels with Temporary Noise Attenuation Pile (TNAP) and bubbles, midwater.	44
Figure 33: Waveform Analysis of Pile P-10 Sound Pressure Levels with TNAP, Midwater.	45
Figure 34: Waveform Analysis of Pile P-16 Sound Pressure Levels Unmitigated after setting for 24-hours, bottom (a) and midwater (b).	46
Figure 35: Waveform Analysis of Pile P-16 Sound Pressure Levels with Mitigation, bottom (a) and second hydrophone on bottom (b). Mitigated with bubbles on bottom (c) and second hydrophone on bottom (d).	48
Figure 36: Waveform Analysis of Pile P-16 Sound Pressure Levels with mitigation and bubbles after setting for a 24-hour period, bottom (a) and midwater (b).	49
Figure 37: Waveform Analysis of Pile Number P-8 Unmitigated Sound Pressure Levels bottom (a) and midwater (b).	50
Figure 38: Waveform Analysis of Pile Number P-8 Mitigated with Bubble Sound Pressure Levels bottom (a) and midwater (b).	51
Figure 39: Waveform Analysis of Pile Number P-14 Mitigated Sound Pressure Levels 754 meters from the pile.	52
Figure 40: Waveform Analysis of Pile Number P-14 Mitigated with Bubbles Sound Pressure Levels 754 meters from the pile.	53
Figure 41: Waveform Analysis of Pile Number P-14 Unmitigated Sound Pressure Levels 754 meters from the pile.	54
Figure 42: Waveform Analysis of Pile Number P-10 Mitigated with Bubbles Sound Pressure Levels 754 meters from the pile.	55
Figure 43: Waveform Analysis of Pile Number P-16 Mitigated Sound Pressure Levels 754 meters from the pile.	56
Figure 44: Waveform Analysis of Pile Number P-16 Mitigated with Bubbles Sound Pressure Levels 754 meters from the pile.	57
Figure 45: Waveform Analysis of Pile Number P-16 Unmitigated after setting for a 24 hour period 754 meters from the pile.	58
Figure 46: Waveform Analysis of Pile Number P-8 Mitigated with Bubbles 754 meters from the pile.	59
Figure 47: Waveform Analysis of Pile Number P-8 Unmitigated Sound Pressure Levels 754 meters from the pile.	60

EXECUTIVE SUMMARY

This technical report describes the data collected during impact pile driving efforts for the Vashon Test Pile Project, Vashon, Washington in November 2009. A total of 4, 30-inch test piles were driven with 1-inch walls. Table 1 summarizes the results for each pile monitored. A new Temporary Noise Attenuation Pile or TNAP developed by the University of Washington, consisting of its Dept. of Mechanical Engineering and Applied Physics Laboratory, henceforth referred to as the UW, was tested as part of this project for its sound reduction properties. The TNAP consisted of a hollow walled steel pile casing filled with mineral wool, thickened steel walls and a bubble ring at the bottom on the inside of the casing. The top of the two walls were acoustically isolated.

Background sound levels measured with a new Autonomous Multichannel Acoustic Recorder at .46 miles (754 meters) from the test piles in 180 feet of water (tidally influenced). Broadband background sound levels ranged between 123 dBRMS to 131 dBRMS and included nearby vessel traffic. The TNAP achieved sound reduction ranging between 8 and 14 dB.

The UW was hired by WSF to make additional measurements to test the effectiveness of their mitigation device. The UW discusses the data in a separate report.

Table 1: Summary Table of Monitoring Results.

Pile	Date	Mitigation Type	Peak (dB)	Average RMS (dB)	Number of Strikes	Average Reduction (dB)	Cumulative SEL _{cum} (dB)
P-14	11/17/09	Unmitigated	215 ¹	194	43	-	200
		Mitigated	207 ¹	189	126	9	201
		Mitigated with Bubbles	206	188	4	9	185
P-10	11/17/09	Mitigated with Bubbles	206	190	103	9	202
P-16	11/17/09	Mitigated	206	187	77	11	197
		Mitigated with Bubbles	204	186	101	13	196
	11/18/09	Mitigated with Bubbles + 24h	203	184	40	14	197
		Unmitigated + 24h	217	195	68	-	204
P-8	11/18/09	Mitigated with Bubbles	204 ¹	187	171	12	199
		Unmitigated	215 ¹	195	47	-	203

¹ – Peak represents underpressure.

INTRODUCTION

This technical report presents results of underwater sound levels measured during the driving of four 30-inch steel piles at the Vashon Ferry Terminal Test Pile Project in November 2009.

The four piles are monitored at different water depths dependent on tidal flux. The mitigation strategy used is a Temporary Noise Attenuation Pile (TNAP) developed by the University of Washington, consisting of its Department of Mechanical Engineering and Applied Physics Laboratory, henceforth referred to as the UW. The TNAP consists of a hollow walled steel casing with insulation filling the hollow wall, a 1-inch steel outer wall and a bubble ring at the base of the casing. Piles are driven with and without the TNAP to determine baseline unmitigated noise levels. During use of the TNAP the inner bubble curtain is also tested with on/off cycles during each pile driving event where it is used. Figure 1 shows the project area and Figure 2 shows the locations of monitored piles.

PROJECT DESCRIPTION

The piles are driven to test the effectiveness of a new modified TNAP developed by the UW. The project location is northeast of the Vashon Ferry Terminal (Figure 1). Water depths at the monitoring locations varied from 37 feet to 40 feet deep. There was an approximate 3 foot tidal flux over a 6 hour period. No substantial currents are observed in the area monitored.

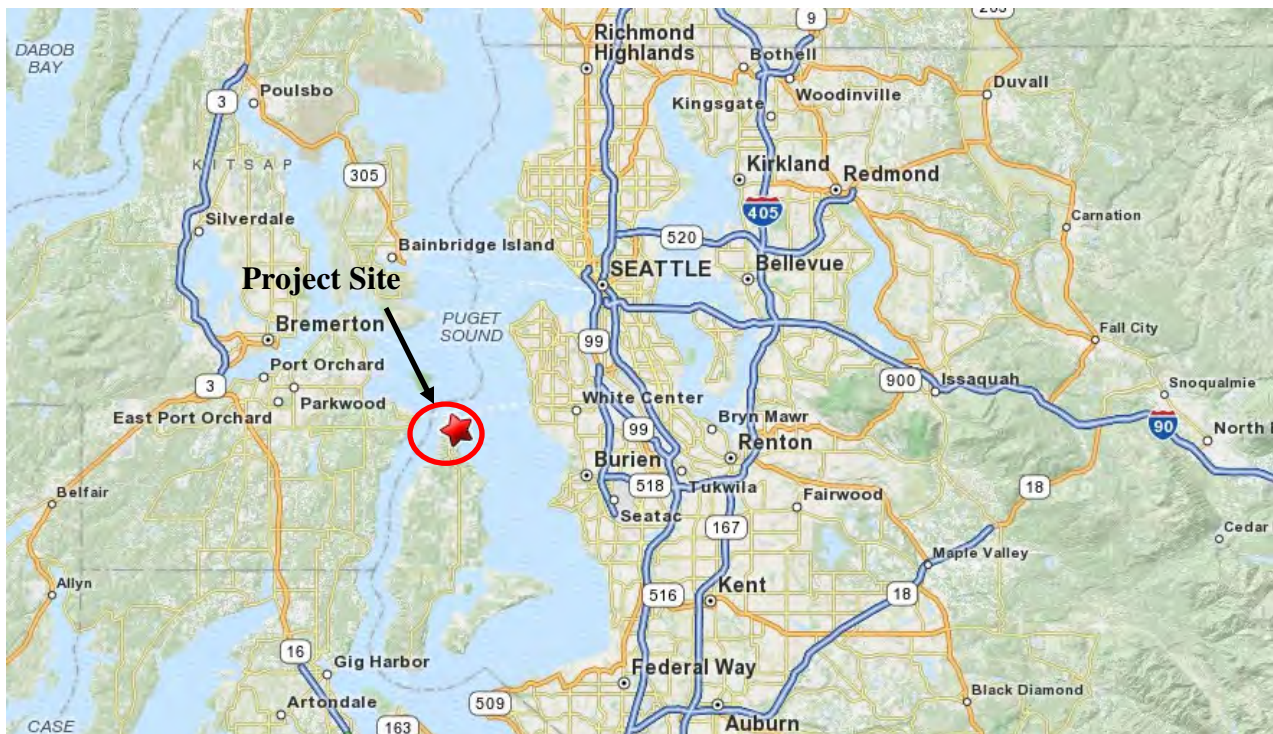

Figure 1: Location of Vashon Test Pile Project at the Vashon ferry terminal.

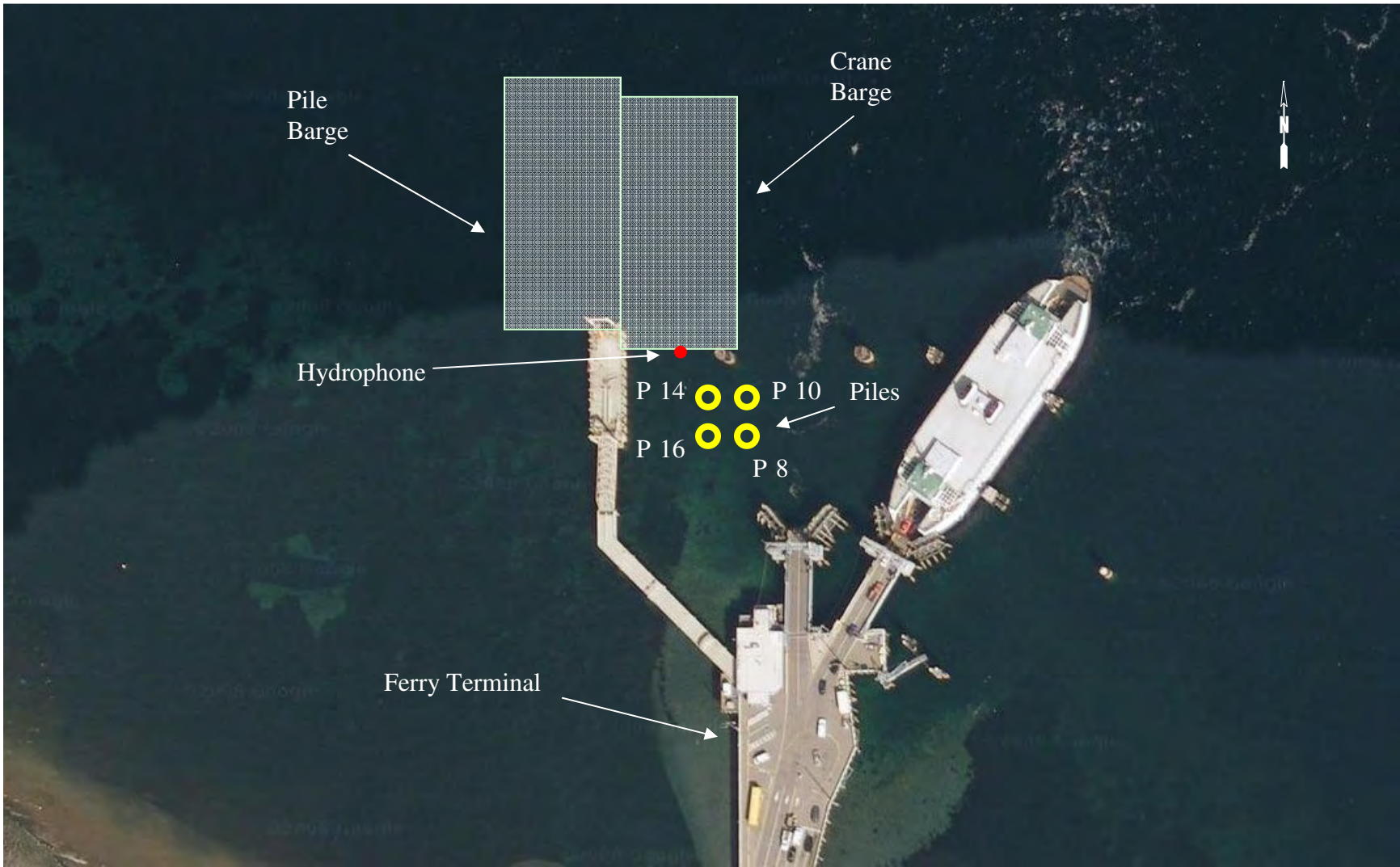

Figure 2: Approximate location of test piles and hydrophone at the Vashon ferry terminal.

UNDERWATER SOUND LEVELS

CHARACTERISTICS OF UNDERWATER SOUND

Several descriptors are used to describe underwater noise impacts. Two common descriptors are the instantaneous peak sound pressure level (SPL) and the Root Mean Square (RMS) pressure level during the impulse, which are sometimes referred to as the SPL and RMS level respectively. The peak pressure is the instantaneous maximum or minimum overpressure observed during each pulse and can be presented in Pascals (Pa) or decibels (dB) referenced to a pressure of 1 micropascal (μPa). Since water and air are two distinctly different media, a different sound pressure level reference pressure is used for each. In water, the most commonly used reference pressure is 1 μPa whereas the reference pressure for air is 20 μPa . The equation to calculate the sound pressure level is:

$$\text{Sound Pressure Level (SPL)} = 20 \log (p/p_{\text{ref}}), \text{ where } p_{\text{ref}} \text{ is the reference pressure (i.e., } 1 \mu\text{Pa for water)}$$

The RMS level is the square root of the energy divided by the impulse duration. This level, presented in dB re: 1 μPa , is the mean square pressure level of the pulse. It has been used by National Marine Fisheries Service (NMFS) in criteria for judging impacts to marine mammals from underwater impulse-type sounds. The majority of literature uses peak sound pressures to evaluate barotraumas injuries to fish. Except where otherwise noted, sound levels reported in this report are expressed in dB re: 1 μPa .

A third descriptor used to describe impacts to fish is the Cumulative Sound Exposure Level (SEL_{cum}). The SEL_{cum} is calculated by first determining the 1-second SEL for a single pile strike which is typically the highest SEL of the entire drive for one pile. The single strike SEL is then plugged into the following formula to calculate the SEL_{cum}.

$$\text{SEL}_{\text{cum}} = \text{Single Strike SEL} + 10 * \text{LOG}(\text{total number of strikes})$$

The calculation of the SEL_{cum} assumes that all pile strikes start with the highest single strike SEL to provide a conservative estimate of the SEL_{cum} since at this time it is not possible to measure the single strike SEL for each individual pile strike.

Rise time is another descriptor used in waveform analysis to describe the characteristics of underwater impulses. Rise time is the time in microseconds (ms) it takes the waveform to go from background levels to absolute peak level.

METHODOLOGY

Underwater sound levels are measured near the pile (nearfield) using two Reson TC 4013 hydrophones deployed on a nylon cord off the end of the crane barge. The analyst positioned one hydrophone at mid-water level and a second one a meter above the bottom. The hydrophone is located at a distance of between 7 and 16 meters (22 to 52 feet) from the individual pile being monitored. The measurement system includes a Brüel and Kjær Nexus type 2692 4-channel signal conditioner, which kept the high underwater sound levels within the dynamic range of the signal analyzer (Figure 3). The output of the Nexus signal conditioner is received by a Dactron Photon 4-channel signal spectrum analyzer that is attached to an Itronix GoBook II laptop computer (Figure 3).



Figure 3: Near field acoustical monitoring equipment

In addition to the near shore noise measurements, far field measurements are collected at distances of approximately half a mile from the piles using an Autonomous Multi-Channel Acoustic Recorder (AMAR mini) from Jasco Research Ltd. in Canada. The AMAR is used to determine the accuracy of the estimated range of impacts to marine mammals according to the NMFS underwater threshold of 120 dB RMS, validate which spreading loss model is most appropriate and collect more accurate background noise levels. WSF hopes measuring underwater noise with the AMAR will allow for fine-tuning of the threshold boundary during future projects.

The AMAR was deployed 0.46 miles from the piles in a water depth of 180 feet (tidally influenced). The AMAR consists of one hydrophone with 0 to 10 kHz bandwidth and a

sensitivity of -160 dB re 1 μ Pa which allows it to be sensitive enough to accurately measure background noise levels (Figure 4). The AMAR has 1 channel of 16-bit, 1 MS/s, solid state storage with 128 GB base, .wav formatted recordings, has a depth rating to 300 meters and can record continuously for up to 10-days in the current configuration. Technicians anchor the AMAR on the bottom and retrieve it using an acoustical release system (Figure 5).

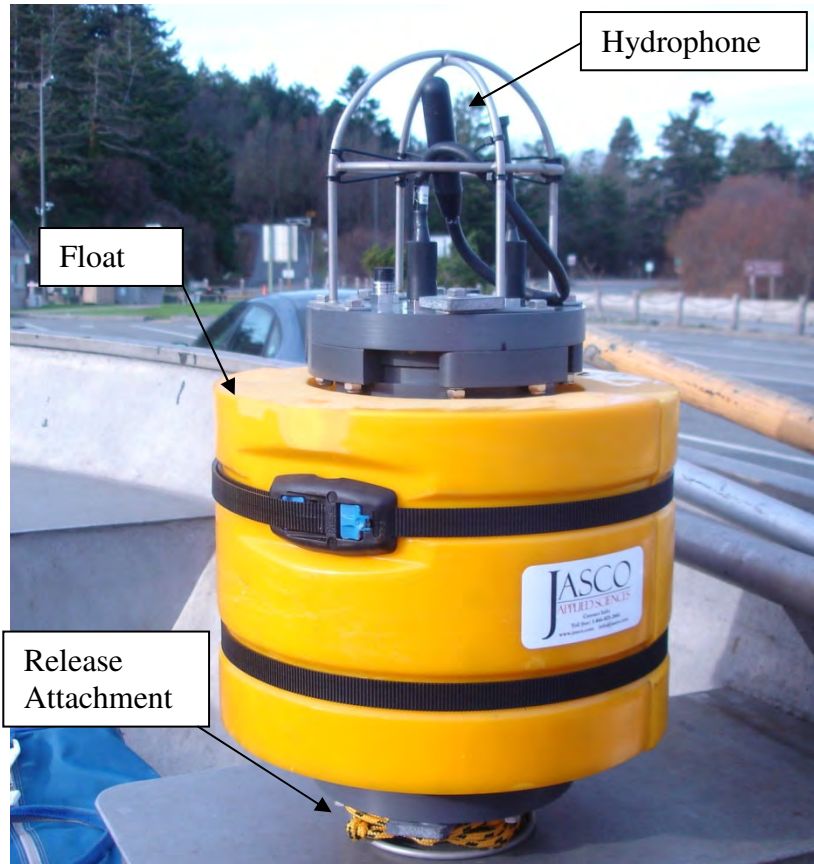

Figure 4: AMAR



Figure 5: Acoustical release for AMAR

The hydrophones capture the waveform of the pile strikes along with the number of strikes, overpressure minimum and maximum, absolute peak values, and RMS sound levels, integrated over 90% of the duration of the pulse, and stored them on the laptop hard drive for subsequent signal analysis. The system and software calibration is checked annually against a NIST traceable standard.

The operation of the nearfield hydrophones were checked daily in the field using a GRAS type 42AC high-level pistonphone with a hydrophone adaptor. The pistonphone signal was 146 dB re: 1 μ Pa. The pistonphone signal levels produced by the pistonphone and measured by the measurement system were within 1 dB and the operation of the system was judged acceptable over the study period.

Signal analysis software provided with the Photon was set at a sampling rate of one sample every 41.7 μ s (9,500 Hz). This sampling rate provides more than sufficient data for the bandwidth of interest for identifying underwater pile driving impact sound and gives sufficient resolution to catch the peaks and other relevant data. The anti-aliasing filter included in the Photon also allows the capture of the true peak.

Due to the high degree of variability between the absolute peaks for each pile strike, an average peak and RMS value is computed along with the standard deviation (s.d.) to give an indication of the amount of variation around the average for each pile.

Average background noise levels (RMS) were calculated using a 60, 30-second RMS values for a single 30 minutes period for every hour of data recorded. Then each 30-second RMS value was averaged over a one-half hour period to estimate the hourly RMS values. The hourly RMS average values were in turn averaged over a 24-hour period to determine what the overall background levels are at this location. Background measurements were only calculated for the first half hour of each hour of data collected to economize on the data analysis. Because the background noise levels a half mile from the ferry terminal is dominated by ferry vessel sounds the arrival and departure of the ferries drive what the background levels will be during any given period. It is assumed that the second half hour would be the same as the first half hour.

The contractor used a vibratory hammer to drive the piles initially. Then the contractor drove all piles to bearing depth with a diesel hammer with a DelMag D62 rated to a maximum of 164,620 foot pounds. This describes the maximum energy output for the diesel hammer and can only be sustained for a few seconds at a time. Actual operation of the diesel hammer is more likely to generate approximately 50% to 70% of this maximum energy for most pile installations.

The substrate consisted of dense sand. This project tests four open-ended hollow steel piles, 30-inches in diameter with a one-inch wall thickness. The technicians made all measurements between 7 meters and and 16 meters from the pile, one meter from the bottom and at mid-water depth.

A clear line of sight between the pile and the hydrophone, with no other structures nearby help to determine the location of the nearfield hydrophones. The distance from the pile to the hydrophone location was measured using a Bushnell Yardage Pro rangefinder. The hydrophone was attached to a weighted nylon cord anchored with a five-pound weight. The cord and hydrophone cables were lowered off the side of the crane barge and kept in this location for all piles monitored (Figure 6).

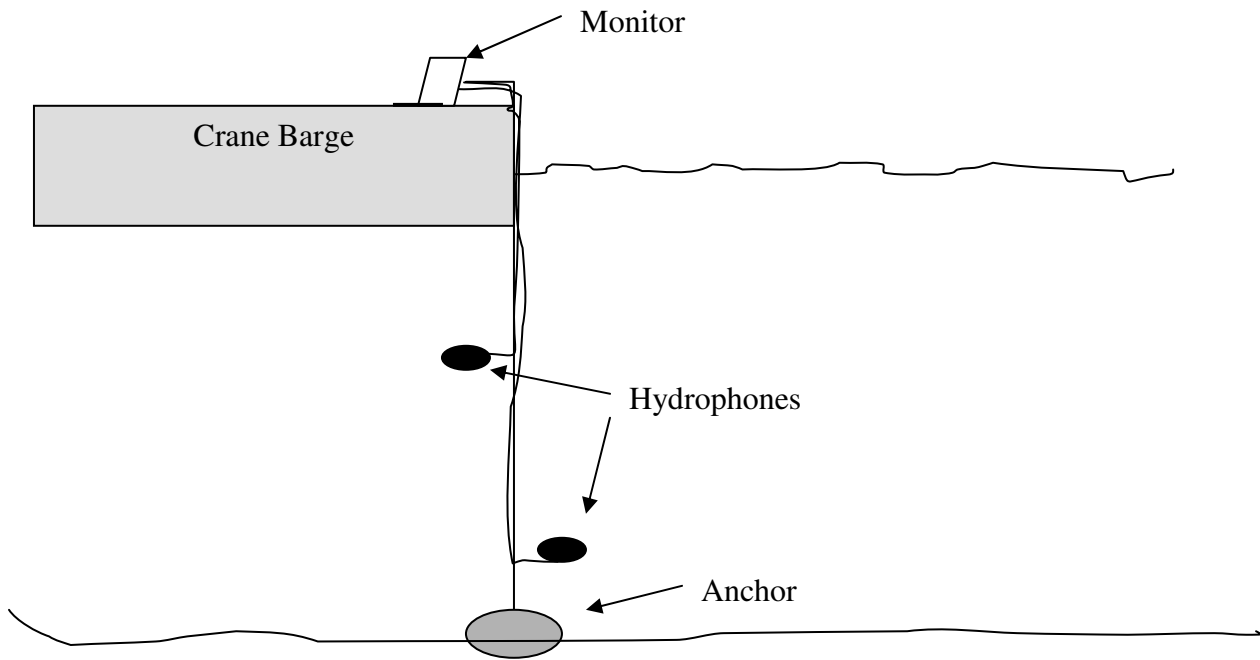

Figure 6: Diagram of hydrophone deployment configuration.

The location of the farfield hydrophone was determined for this project by deploying the AMAR near the calculated action area boundary at approximately 0.5 miles from the piles and allowing a clear line of sight between the pile and the hydrophone, with no other structures nearby and out of the direct path of ferry vessel traffic. The distance from the pile to the hydrophone location was measured using GPS coordinates and GIS. The AMAR and hydrophone was attached to an acoustical release. The acoustical release was attached to a weighted nylon cord anchored with a five-pound weight (Figure 7). The AMAR was kept in this position for the duration of the pile driving activities.

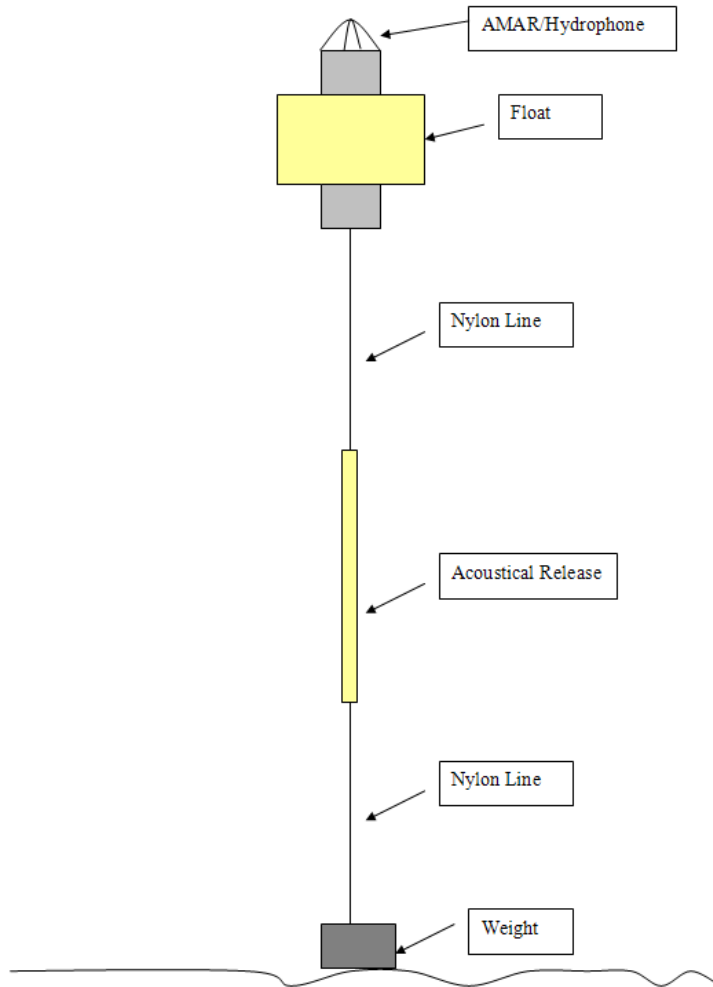

Figure 7: Diagram of AMAR deployment configuration

TEMPORARY NOISE ATTENUATION PILE (TNAP) DESIGN

Part of this project tests a modified Temporary Noise Attenuation Pile (TNAP) device. The TNAP tested (TNAP) consist of a hollow steel pile casing with a 2-inch foam filled hollow wall (Figure 8) and a bubble ring on the inside at the bottom. The contactor places the TNAP around the driven pile on the sediment surface and extending up to a few feet above the surface waterline.

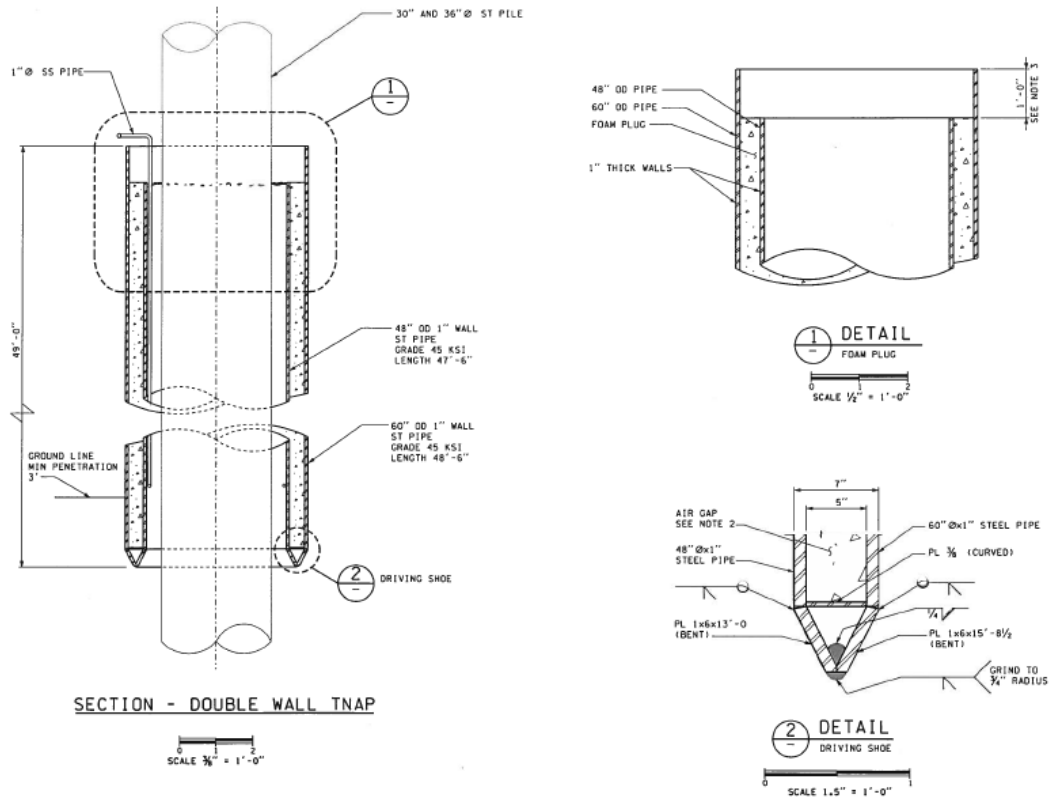

Figure 8: Modified Double Walled TNAP Schematics from the University of Washington Applied Physics Laboratory.

RESULTS

UNDERWATER SOUND LEVELS

In the waveform figures below, the axes all have the same scale for each pile. This will facilitate visual comparisons between piles with and without mitigation. Many interesting attributes of the waveforms of different piles and mitigation types will become evident. A brief description of the tested piles and pile types follows:

PILE P-14

Pile P-14 was driven with a diesel hammer in a water depth of 37 feet and utilized the hollow walled foam filled Temporary Noise Attenuation Pile (TNAP) developed by the University of Washington Applied Physics Lab team. The TNAP also utilized a bubble ring at the bottom inside of the inner wall. The hydrophone for Pile P-14 was located 7 meters from the pile. The sound levels for Pile P-14 in Table 2 indicate that when the TNAP with no bubbles versus no TNAP is compared there was a 9 decibel noise reduction 1 meter from the bottom. There was no data for the unmitigated mid-water position. The bubbles were turned on at the end of the drive and then the pile was struck an additional four times.

After retrieving the hydrophones at the end of the day the midwater hydrophone had come loose from its attachment to the rope it was suspended on and it slipped to the bottom and was likely muffled by the mud on the bottom. The results for the unmitigated piles P-14 and P-10 were not useable and discarded.

Figure 9a represents the peak pile strike waveform without the TNAP. When compared to the peak strike waveform for Pile P-14 with the TNAP but with no bubbles (9b) the pile strike while using the TNAP appears to slightly decrease the overall amplitude, but not as much as expected. The average peak sound reductions achieved with the TNAP for Pile P-14 was 9 dB.

Figure 9c compares the average narrow band frequencies of three successive peak pile strikes from Pile P-14 with and without the TNAP. In this spectral analysis the TNAP appears to suppress some of the higher frequencies above approximately 5000 Hz which also correlates to the slight drop in amplitude of the peak strike seen in Figure 9b.

Figure 9: Waveforms and frequency spectral analysis for Pile P-14 using TNAP.

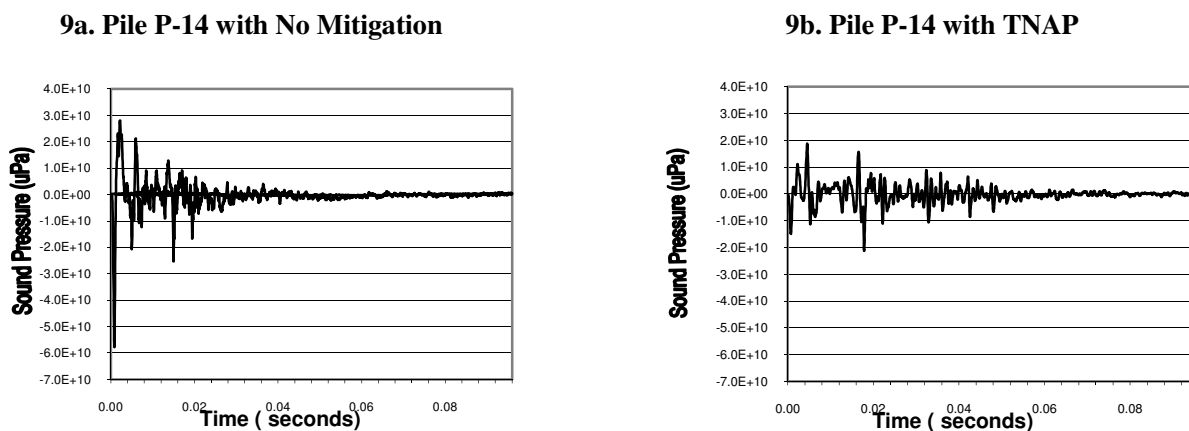

9c. Pile P-14 with TNAP Frequency Data Compared to Pile P-14 with No Mitigation, 1 meter from bottom

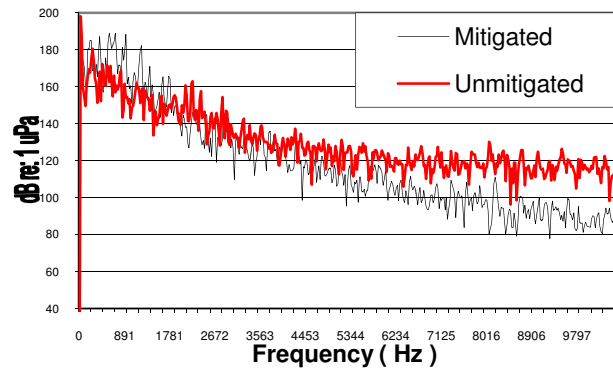

Figure 10a represents the peak pile strike waveform with the TNAP but with no bubbles. Compared to the peak strike waveform for Pile P-14 with the TNAP (10b) and bubbles on, the bubbles appear to provide a slight additional decrease in the overall amplitude of the pile strike and a stretching of the waveform indicating a reduction of the energy resulting from bubbles inside the TNAP, but still not as much as expected.

Figure 10c compares the average narrow band frequencies of the three successive pile strikes with no mitigation and with the TNAP and bubbles on. It can be seen in Figure 10c that there is further suppression of the higher frequencies and some suppression of some of the lower frequencies down to approximately 1000 Hz which also correlates to the drop in amplitude of the peak pile strike seen in Figure 10b.

Table 2 indicates the results of monitoring for Pile P-14. It shows a 215 dB_{peak} as the highest unmitigated absolute peak measured at the hydrophone 1 meter from the bottom. The highest unmitigated average RMS, 1 meter from the bottom is 194 dB_{RMS}. The highest unmitigated single strike SEL for the peak strike 1 meter from the bottom was 184 dB_{SEL}. As can be seen in Appendix A Figure 30 the waveform analysis for Pile P-14 indicates that there was a relatively short delay between the initial onset of the impulse and the absolute peak (rise time of 0.8 milliseconds).

The cumulative unmitigated SEL in Table 2 exceeded the current criteria of 187 dB_{SELcum} after only one strike.

Figure 10: Waveforms and frequency spectral analysis for Pile P-14 using TNAP + Bubbles.

10a. Pile P-14 with TNAP

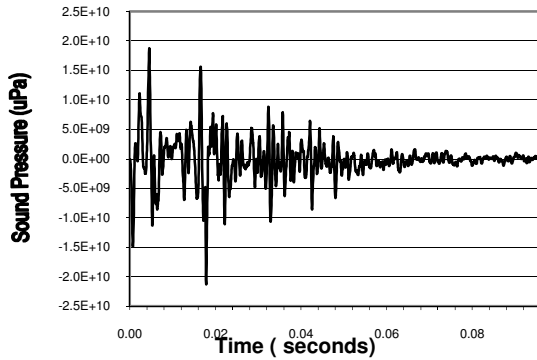

10b. Pile P-14 with TNAP + Bubbles

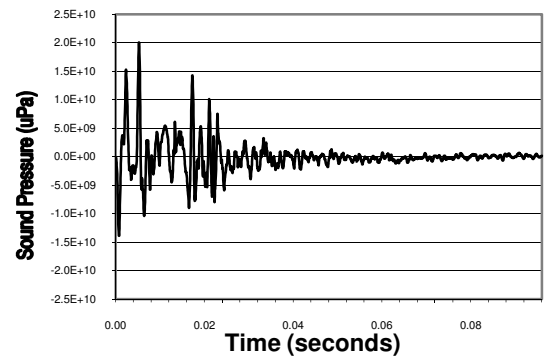

10c. Pile P-14 with TNAP + Bubbles Frequency Data Compared to Pile P-14 with No Mitigation, 1 meter from bottom

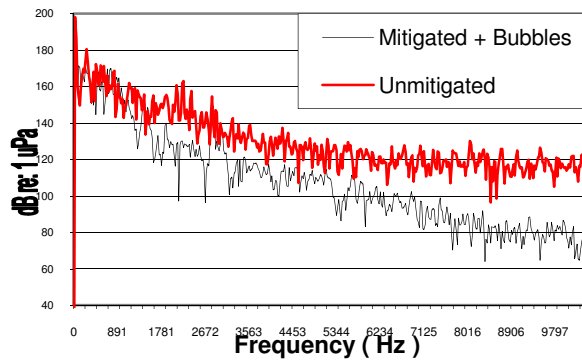

Table 2: Summary of Underwater Sound Levels for the Vashon Test Pile Project, Steel Piles.

Pile	Date	Mitigation Type	Hydrophone Depth (feet)	Peak (dB)	Avg. RMS \pm s.d. (Pascals)	Avg. dB_{RMS}	Total # of Strikes	Avg. Peak \pm s.d. (Pascals)	Avg. dB_{Peak}	Avg. Reduction ³ (dB)	Single Strike SEL (dB)	Rise Time (millesec.)	Cumulative SEL (dB)	% of Strikes Over 187 dB (Cum SEL)
P-14	11/17/09	Unmitigated	19 ¹	-	-	-	-	-	-	-	-	-	-	-
			37	215 ²	5181 \pm 751	194	43	49827 \pm 12752	214	-	184	0.8	200	42
		Mitigated	19 ¹	207 ²	2851 \pm 538	189	126	18075 \pm 2255	205	9	180	18.2	201	122
			37	207 ²	2842 \pm 378	189	126	18643 \pm 1877	205	9	181	18.6	202	122
		Mitigated with Bubbles	19 ¹	205 ²	2578 \pm 243	188	4	17153 \pm 2119	205	9	179	5.4	185	0
			37	206	2456 \pm 599	188	4	18581 \pm 1818	205	9	179	5.5	185	0
P-10	11/17/09	Mitigated with Bubbles	36	206	3293 \pm 363	190	103	16915 \pm 1111	205	9	182	19.0	202	100
P-16	11/17/09	Mitigated	19 ¹	206	2393 \pm 224	188	77	17442 \pm 1343	205	11	179	4.8	198	71
			37	206	2192 \pm 163	187	77	17524 \pm 753	205	11	178	4.7	197	69
		Mitigated with Bubbles	19 ¹	203	1954 \pm 194	186	101	12800 \pm 981	202	14	176	5.5	196	89
			37	204	1897 \pm 182	186	101	14379 \pm 1105	203	13	176	5.5	196	89
	11/18/09	Mitigated with Bubbles +24h	20	200	1157 \pm 220	182	40	8454 \pm 1517	198	14	172	14.7	188	5
			37	203	1625 \pm 336	184	40	13311 \pm 2641	202	14	176	5.6	197	129
		Unmitigated +24 h	20	213	3413 \pm 578	191	68	39350 \pm 6484	212	-	181	1.4	199	64
			37	217	5433 \pm	195	68	62227 \pm	216	-	186	1.0	204	67

Pile	Date	Mitigation Type	Hydrophone Depth (feet)	Peak (dB)	Avg. RMS \pm s.d. (Pascals)	Avg. dB _{RMS}	Total # of Strikes	Avg. Peak \pm s.d. (Pascals)	Avg. dB _{peak}	Avg. Reduction ³ (dB)	Single Strike SEL (dB)	Rise Time (millesec.)	Cumulative SEL (dB)	% of Strikes Over 187 dB (Cum SEL)
					773			8719						
P-8	11/18/09	Mitigated with Bubbles	20	202 ²	1549 \pm 198	184	171	10099 \pm 1105	200	8	175	1.8	196	110
			37	204 ²	2156 \pm 287	187	171	12291 \pm 1441	202	12	178	1.8	199	118
		Unmitigated	20	210 ²	2902 \pm 512	189	47	26048 \pm 3969	208	-	181	15.9	198	42
			37	215 ²	5908 \pm 907	195	47	52361 \pm 6320	214	-	186	1.1	203	46

¹ – Midwater (17 foot depth) hydrophone slipped to bottom substrate and did not accurately record noise levels; data discarded.

² – Peak represents underpressure.

³ – Average reduction is calculated by subtracting the average peak sound level for each mitigation strategy employed from the average peak unmitigated Pile 1.

PILE P-10

Pile P-10 is driven in a water depth of 39 feet with a TNAP with bubbles in place. The hydrophone for Pile P-10 is located 11 meters from the pile. There are no data for the midwater position due to a problem with the midwater hydrophone and Pile P-10 is not driven without the TNAP. The bubbles are turned on for the entire drive.

Table 2 indicates the highest absolute peak recorded for this pile is 206 dB_{peak} with the bubbles on. The highest average RMS with the bubbles on is 190 dB_{RMS} and the highest single strike SEL is 182 dB_{SEL} with the bubbles on. These values are similar to those measured for the bottom hydrophone on Pile P-14 with both the TNAP and bubbles on.

PILE P-16

Pile P-16 is driven in a water depth of 37 feet utilizing the TNAP. The hydrophone for Pile P-16 is located 15 meters from the pile. The pile is driven with the TNAP but without the bubbles for the first two minutes and then with bubbles for the last three minutes.

Figure 11a indicates the difference between the average narrow band frequencies of three successive pile strikes with the TNAP in place compared to with no mitigation. Figure 11b indicates the narrow band frequencies of the average of three successive pile strikes with the TNAP and bubbles compared to without mitigation.

In Figure 11c the narrow band frequencies of the average of three successive pile strikes with the TNAP and bubbles on after the pile and TNAP had sat in place overnight. It appears that there is very little difference in the mitigation effectiveness after having sat overnight.

In Figure 11d the average narrow band frequencies of three successive pile strikes with the TNAP and bubbles on compared to with bubbles off. This figure indicates that there is very little if any value added by turning the bubbles on with the TNAP in place.

Table 2 indicates the highest absolute peak recorded for this pile is 217 dB_{peak} without the TNAP. The highest unmitigated average RMS is 195 dB_{RMS}. The highest single strike SEL for the peak strike is 186 dB_{SEL} without the TNAP. The average peak sound reductions achieved with the TNAP for Pile P-16 ranged between 11 and 14 dB.

Figure 11: Waveforms and frequency spectral analysis for pile P-16 using TNAP2.

11a. Pile 3 with Mitigation (TNAP)

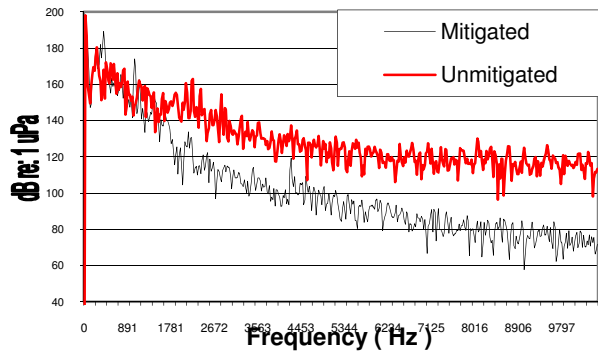

11b. Pile 3 with Mitigation (TNAP) & Bubbles

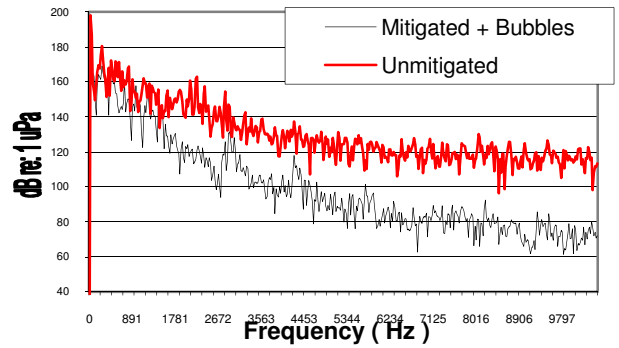

11c. Pile 3 with TNAP and Bubbles after 24 hours

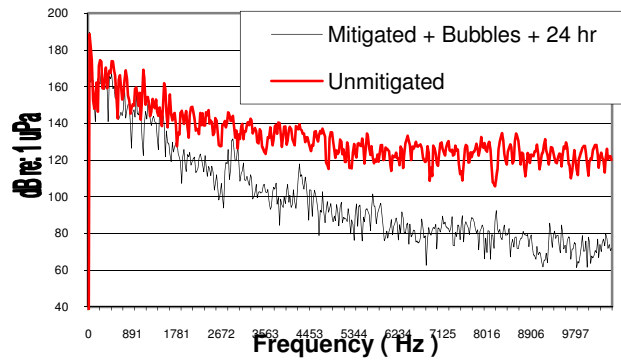

11d. Pile 3 with TNAP with and without Bubbles

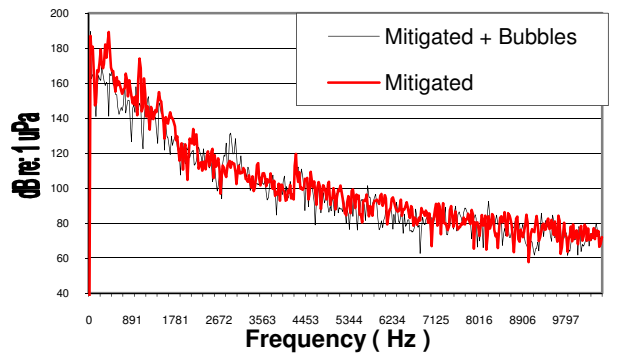

PILE P-8

Pile P-8 was driven in water depth of 40 feet and relatively firm sediments 16 meters from the pile with the TNAP in place and the bubbles turned on to begin.

Figure 12a indicates the difference between the peak strike waveform with TNAP in place compared to without the TNAP and bubbles (12b). Figure 12a shows a modest reduction in the amplitude of the waveform with mitigation in place.

In Figure 11c the narrow band frequencies of the average of three successive pile strikes comparing both with the TNAP and bubbles and without indicate that the mitigation reduces the sound levels at most frequencies except the lowest frequencies.

Table 2 indicates the highest absolute peak recorded for this pile was 215 dB_{peak} unmitigated. The highest average RMS is 195 dB_{RMS} unmitigated. The highest single strike SEL for the peak strike is 186 dB_{SEL} unmitigated. The average peak sound reductions achieved with the TNAP ranged between 8 and 12 dB for Pile P-8.

Figure 12: Waveforms and frequency spectral analysis for pile P-8 using the TNAP.

12a. Pile P-8 with TNAP and bubbles

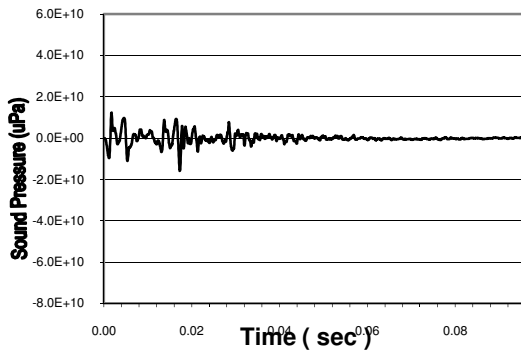

12b. Pile P-8 (No Mitigation)

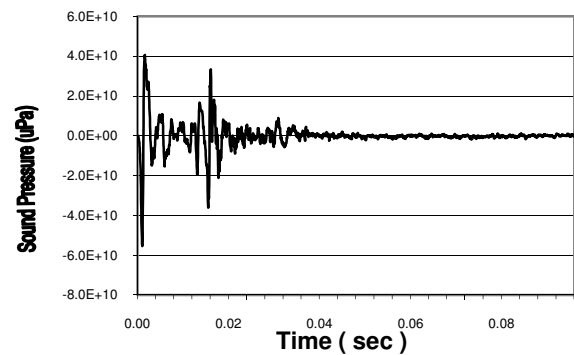

12c. Pile P-8 with TNAP and bubbles Frequency Data Compared with No Mitigation

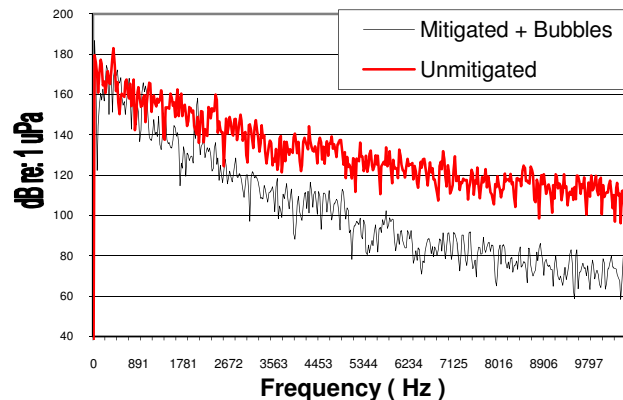

AMAR MEASUREMENTS

In addition to the near shore noise measurements, far field measurements were taken at a remote location of 754 meters from the piles using an Autonomous Multi-Channel Acoustic Recorder (AMAR mini) from Jasco Research Ltd. in Canada. The AMAR was used to determine the accuracy of the estimated range of impacts to marine mammals according to the NMFS underwater threshold of 160 dB RMS. WSF is concerned that the practical spreading model used by NMFS is overly conservative and hopes to use information collected with the AMAR to suggest a more appropriate model (e.g. spherical or cylindrical). WSF hopes measuring underwater noise with the AMAR will allow for fine-tuning of the threshold boundary during future projects.

For this project, the AMAR was deployed at a single distance and depth to monitor the impact pile driving effort: 754 meters (2,473 feet or 0.47 miles) for all piles (Figure 13). This device is used to determine if the original estimated range of impacts to marine mammals was accurate or if it was too conservative. It is hoped that information collected using the AMAR mini will enable WSF to suggest a more appropriate model (e.g. spherical or cylindrical) to use that is still conservative but not as conservative as the practical spreading model. It is hoped that for some WSF projects that the AMAR will allow a fine tuning of the threshold boundary during the project.

Comparison of Near Field and Far Field Underwater Measurements

The data presented in Table 3 indicates that the impact pile driving sounds were still well above background noise levels but 21 to 36 dB lower than near the source (transmission loss). The RMS levels ranged between 152 dB RMS and 165 dB RMS. At this distance piles P-14, P-10 and P-16 during the first day of driving were all below the 160 dB RMS threshold at this distance.



Figure 13: Locations of AMAR deployment relative to the nearfield impact monitoring location at Vashon Ferry Terminal.

Table 3: Summary of Underwater Sound Levels from the AMAR Mini for the Vashon Test Pile Project, Steel Piles.

Pile	Date	Mitigation Type	Peak (dB)	Avg. RMS \pm s.d. (Pascals)	Avg. dB_{RMS}	Avg. Peak \pm s.d. (Pascals)	Avg. dB_{peak}	Avg. Reduction ¹ (dB)	Single Strike SEL (dB)	Transmission Loss ² (dB_{RMS})
P-14	11/17/09	Unmitigated	168	85 \pm 26	159	214 \pm 71	167	-	150	35
		Mitigated	168	71 \pm 19	157	235 \pm 4	167	0	150	30
		Mitigated with Bubbles	168	41 \pm 36	152	109 \pm 113	161	6	149	36
P-10	11/17/09	Mitigated with Bubbles	168	88 \pm 10	159	238 \pm 10	168	0	150	31
P-16	11/17/09	Mitigated	168	76 \pm 9	158	234 \pm 11	167	7	148	29
		Mitigated with Bubbles	168	67 \pm 6	157	237 \pm 5	167	7	147	29
	11/18/09	Mitigated with Bubbles +24h	174	138 \pm 28	163	471 \pm 76	167	7	155	21
		Unmitigated +24 h	174	170 \pm 22	165	491 \pm 57	174	-	155	30
P-8	11/18/09	Mitigated with Bubbles	174	155 \pm 19	164	487 \pm 5	174	0	155	23
		Unmitigated	174	185 \pm 22	165	479 \pm 75	174	-	156	30
Overall Average								4		29.3

¹ – Average reduction is calculated by subtracting the average peak sound level for each mitigation strategy employed from the average peak unmitigated pile.

² - Transmission loss is a complicated function of local bathymetry, sound-speed profile, range, source frequency, absorption, and scattering (Medwin and Clay, 1998). However, if it is possible to measure both the source and received sound pressure levels, the equation below may be used to calculate the transmission loss (Carr et al., 2006).

$TL_{dB} = SL_{dB} - RL_{dB}$; where SL_{dB} is the measured source level and RL_{dB} is the measured received level

While NMFS uses the practical spreading model to determine the threshold boundary distance, WSF is proposing the use of the spherical model. An example comparison of the two models is described below.

- Practical Spreading Model ($R_1 = R_0 * 10^{(195-160/15)}$): Assesses the 160 dB_{RMS} threshold for marine mammals from the Pile P-16 location and measuring 195 dB_{RMS} at 15 meters, the NMFS marine mammal calculator results in a threshold boundary 1.5 miles from the pile.
- Spherical Spreading Model ($R_1 = R_0 * 10^{(195-160/20)}$): Using the most conservative average RMS value of 195 dB_{RMS} for Pile P-16 and inputting it into the NMFS calculator for marine mammal thresholds, the sound levels should reach the 160 dB_{RMS} threshold at approximately 0.4 miles (i.e., the 160 dB_{RMS} threshold is reached within 96 meters from the AMAR).

Based on our measurements, the practical spreading model appears overly conservative since it predicts that the measured sound level would occur over 0.5 miles further out. Comparing the measured AMAR results at 0.5 miles (806 meters) using all three spreading models (practical, spherical and cylindrical) it appears, that on average, the spherical model is more accurate at modeling the actual distance of the measured RMS level for each pile (within an average distance of 422 feet) (Table 4).

Table 4: Comparison of different spreading models using actual measured data.

Spreading Model	Distance From Pile (meters)	Pile #	Transmission Loss ¹	Calculated Meters To Measured RMS	Calculated Miles To Measured RMS	Measured Distance at Received RMS (miles)	Distance to 160 dB RMS Threshold Level (Miles)
Practical	7	P-14	36	1508	0.94	0.46	2.6
	11	P-10	31	1283	0.80	0.46	2.2
	15	P-16	30	1500	0.93	0.46	6.6
	16	P-8	30	1600	0.99	0.46	7.0
	Average				0.92		
Spherical	7	P-14	36	394	0.24	0.46	0.22
	11	P-10	31	390	0.24	0.46	0.22
	15	P-16	30	474	0.29	0.46	0.52
	16	P-8	30	506	0.31	0.46	0.56
	Average				0.27		
Cylindrical	7	P-14	36	22,136	13.75	0.46	10.9
	11	P-10	31	13,848	8.60	0.46	6.8
	15	P-16	30	15,000	9.32	0.46	29.5
	16	P-8	30	16,000	9.94	0.46	31.4
	Average				10.4		

¹ - $TL_{dB} = SL_{dB} - RL_{dB}$; where SL_{dB} is the measured source level and RL_{dB} is the measured received level. The highest transmission loss for each pile is used here to represent the most conservative scenario.

Figure 14 through 27 show the relative differences for each pile strike between the near field RMS values, the far field RMS values and the average background RMS values for Piles P-14, P10, P16 and P8. As the figures indicate, the near field RMS values are somewhat variable, whereas the far field measurements are much less variable. The far field measurements were

approximately 25 to 30 dB less than the near field measurements and were approximately 25 to 35 dB above background. For piles P-14 and P-10 the near field midwater hydrophone dropped to the bottom during deployment and so there no difference between the two datasets. Only data for the bottom measurement is presented here. For piles P-16 and P-8 the near field midwater measurements were collected successfully and presented here in the following figures.

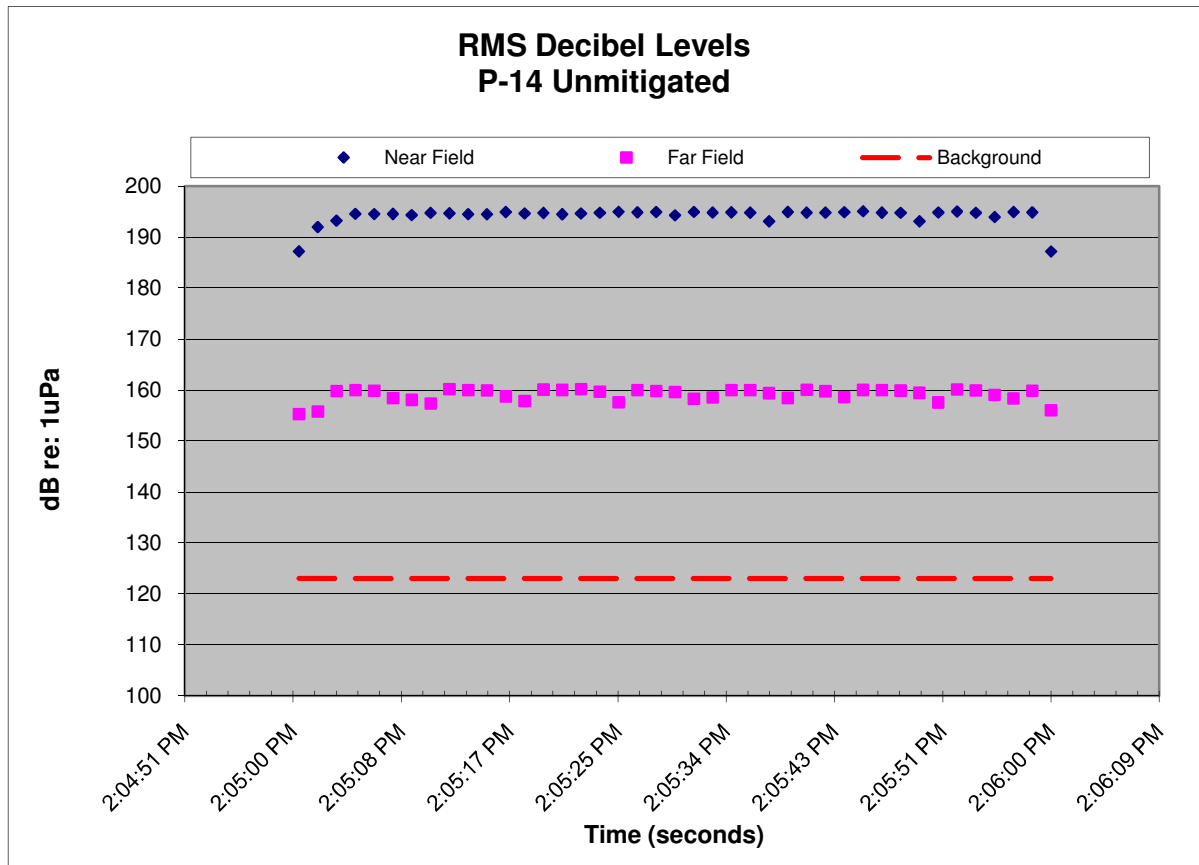

Figure 14: Pile P-14 (bottom) - Comparison of unmitigated Root Mean Square values (RMS) for individual hammer strikes at 7 meters (near field) and 754 meters (far field) from the pile. Average background RMS values are also included.

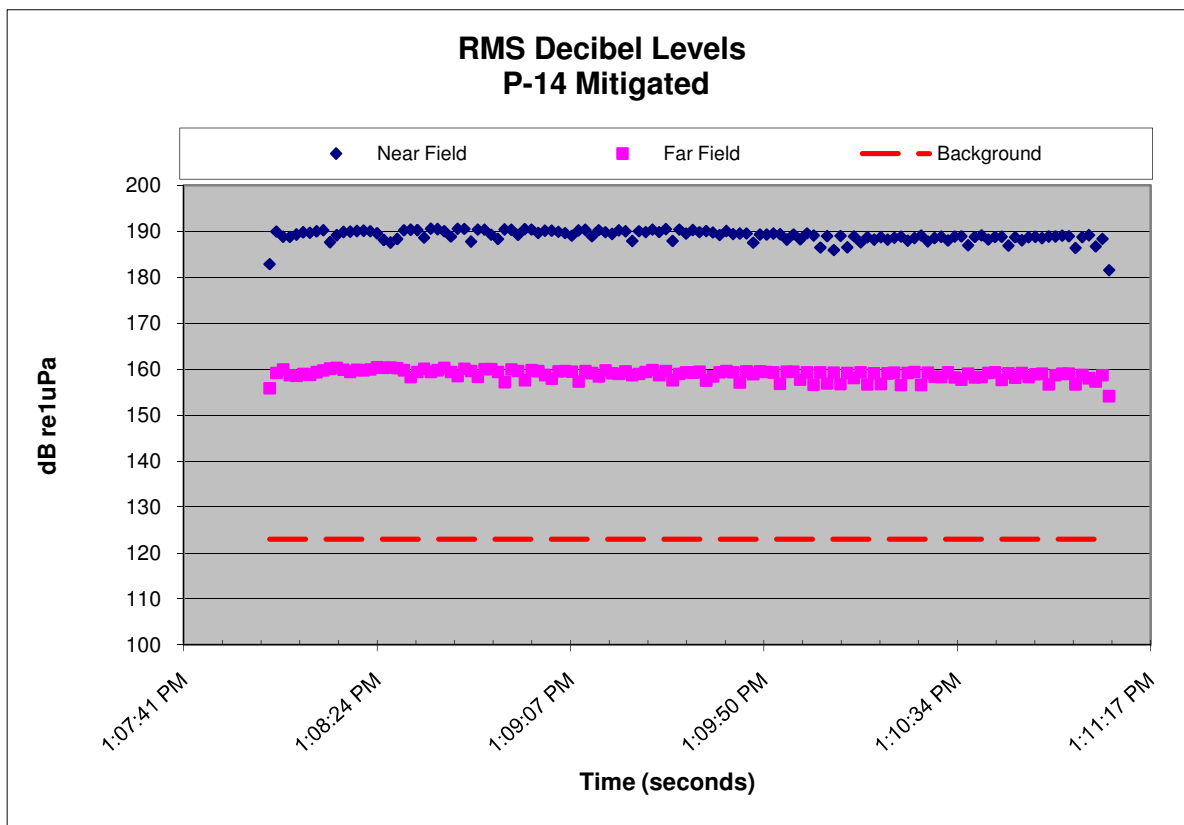

Figure 15: Pile P-14 (bottom) - Comparison of mitigated Root Mean Square values (RMS) for individual hammer strikes at 7 meters (near field) and 754 meters (far field) from the pile. Average background RMS values are also included.

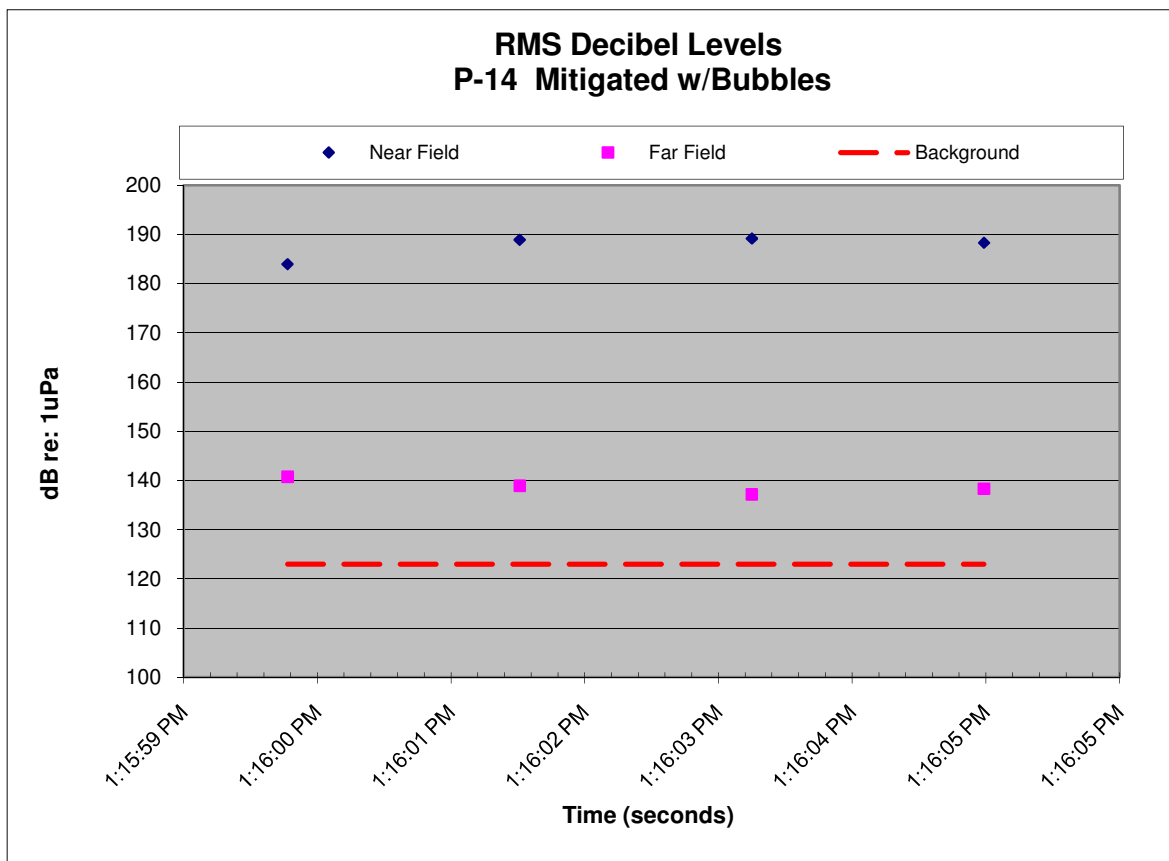

Figure 16: Pile P-14 (bottom) - Comparison of mitigated with bubbles Root Mean Square Values (RMS) for individual hammer strikes at 7 meters (near field) and 754 meters (far field) from the pile. Average background RMS values are also included.

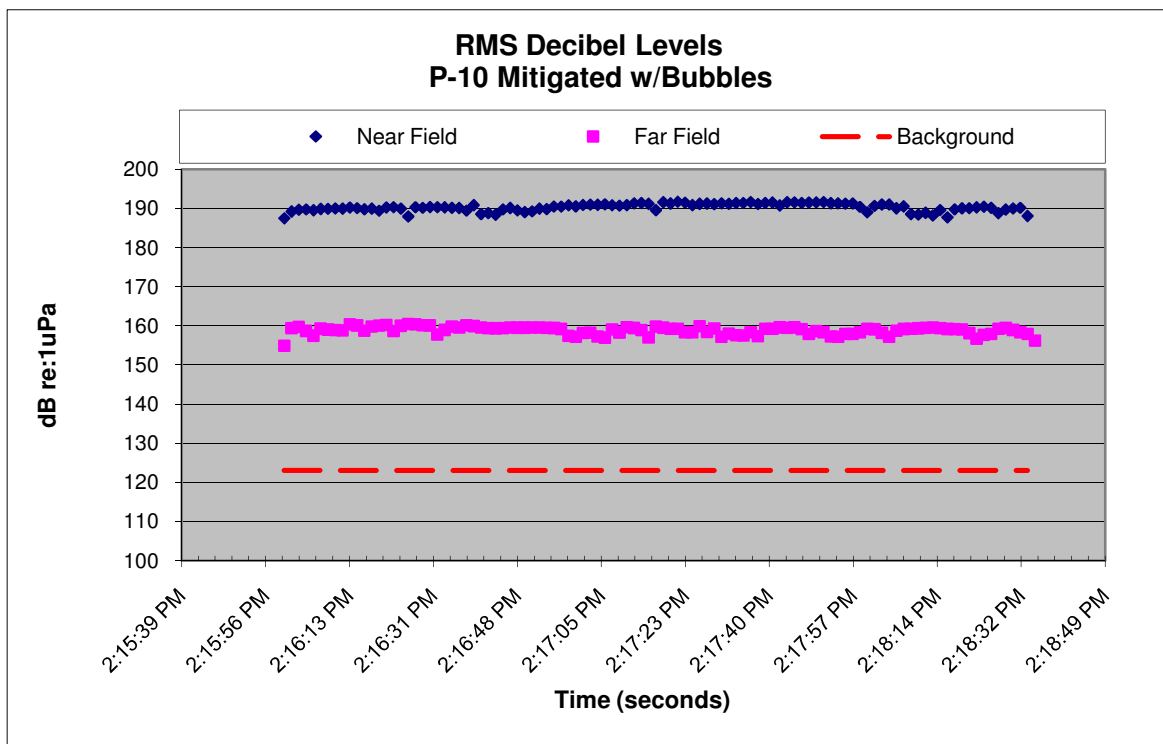

Figure 17: Pile P-10 (bottom) - Comparison of mitigated with bubbles Root Mean Square values (RMS) for individual hammer strikes at 11 meters (near field) and 754 meters (far field) from the pile. Average background RMS values are also included.

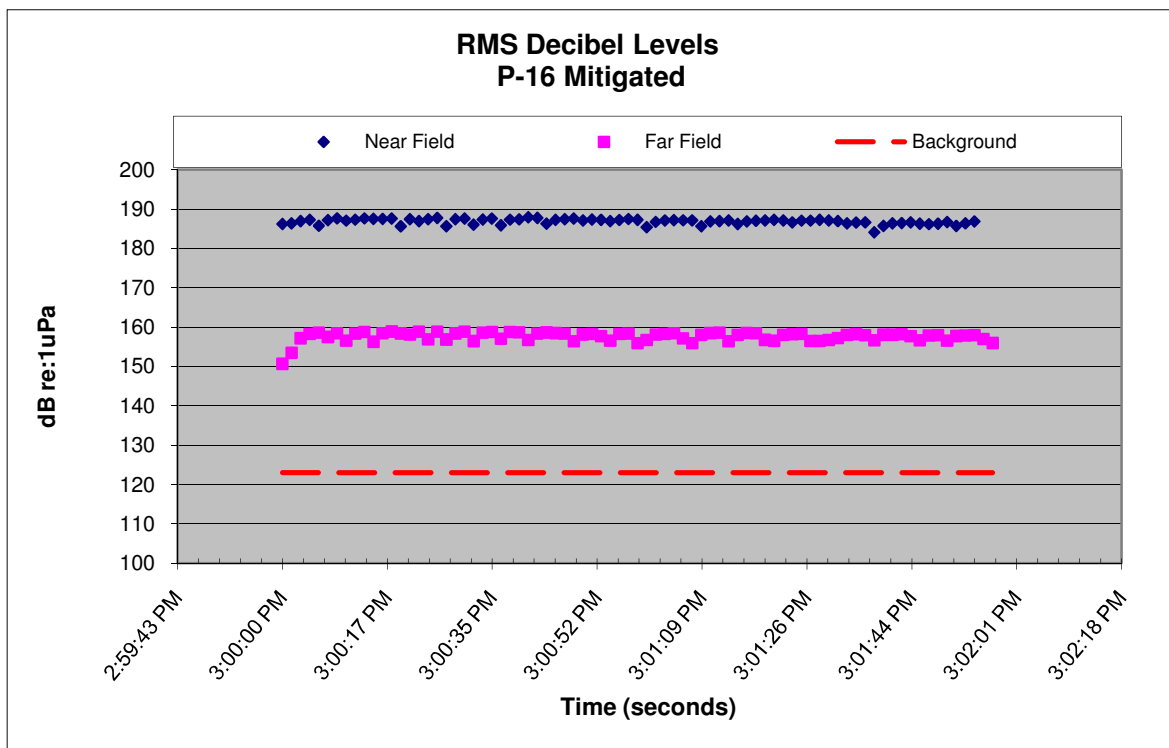

Figure 18: Pile P-16 (bottom) - Comparison of mitigated Root Mean Square values (RMS) for individual hammer strikes at 15 meters (near field) and 754 meters (far field) from the pile. Average background RMS values are also included.

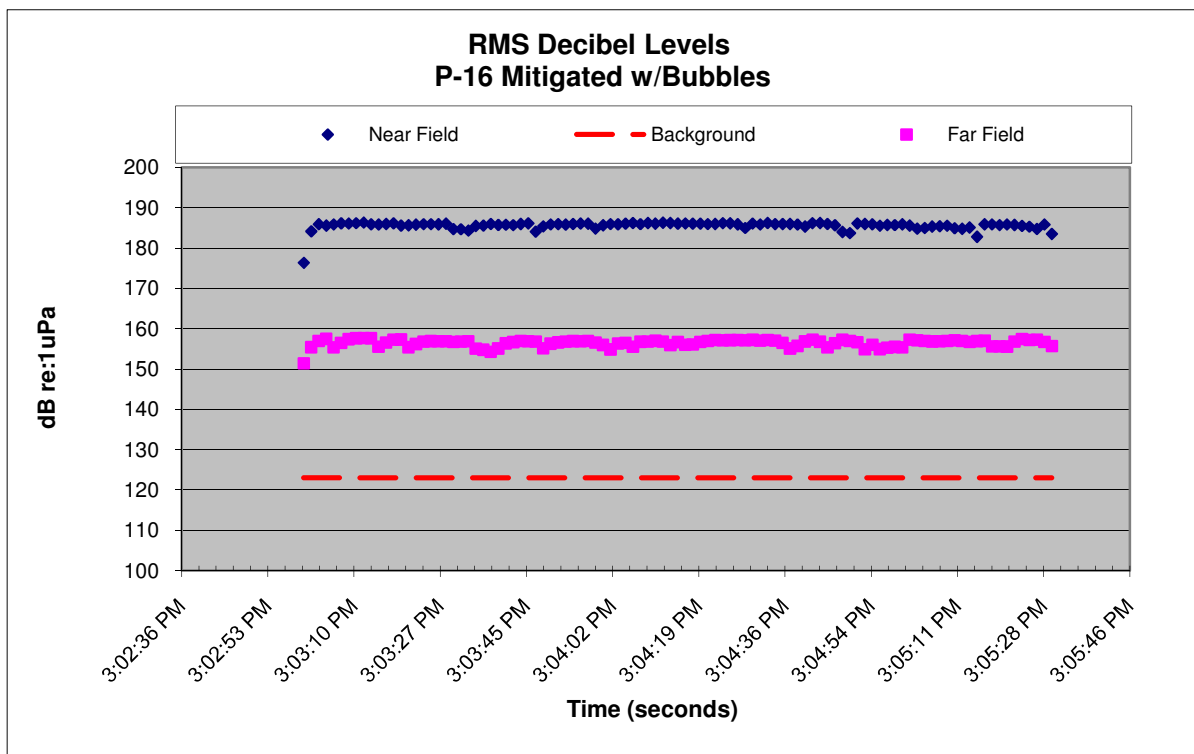

Figure 19: Pile P-16 (bottom) - Comparison of mitigated with bubbles Root Mean Square values (RMS) for individual hammer strikes at 15 meters (near field) and 754 meters (far field) from the pile. Average background RMS values are also included.

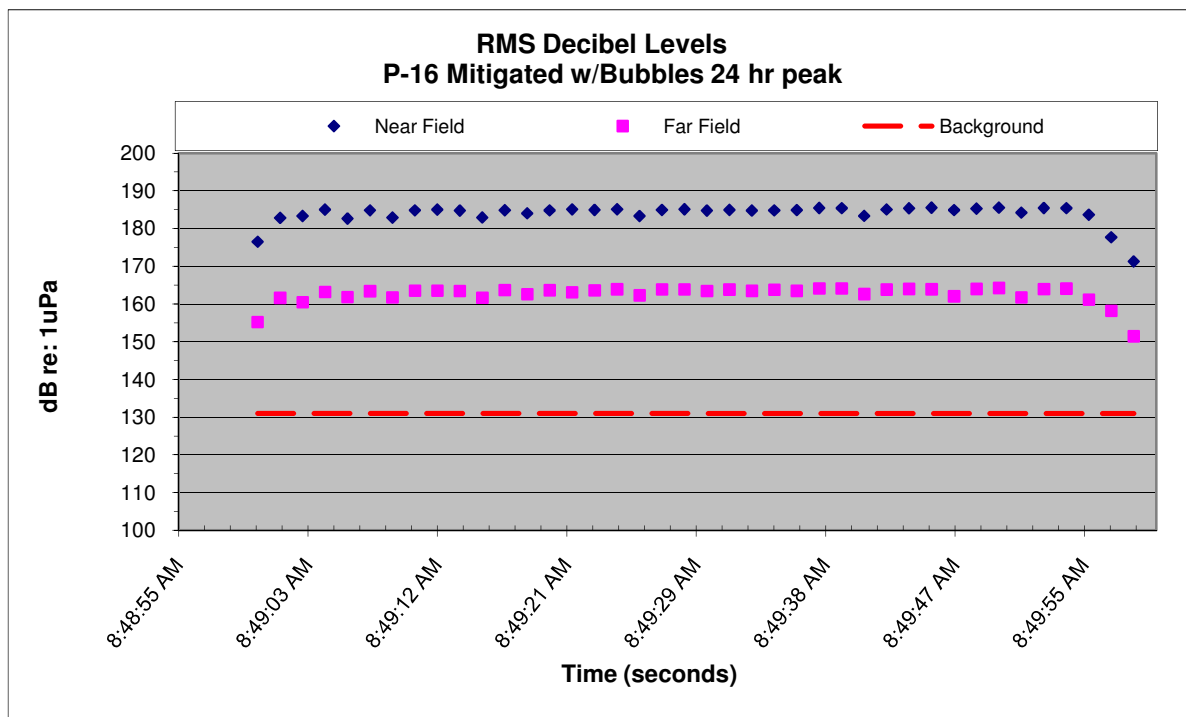

Figure 20: Pile P-16 (bottom) - Comparison of mitigated with bubbles Root Mean Square values (RMS) for individual hammer strikes at 15 meters (near field) and 754 meters (far field) from the pile after a 24-hour period. Average background RMS values are also included.

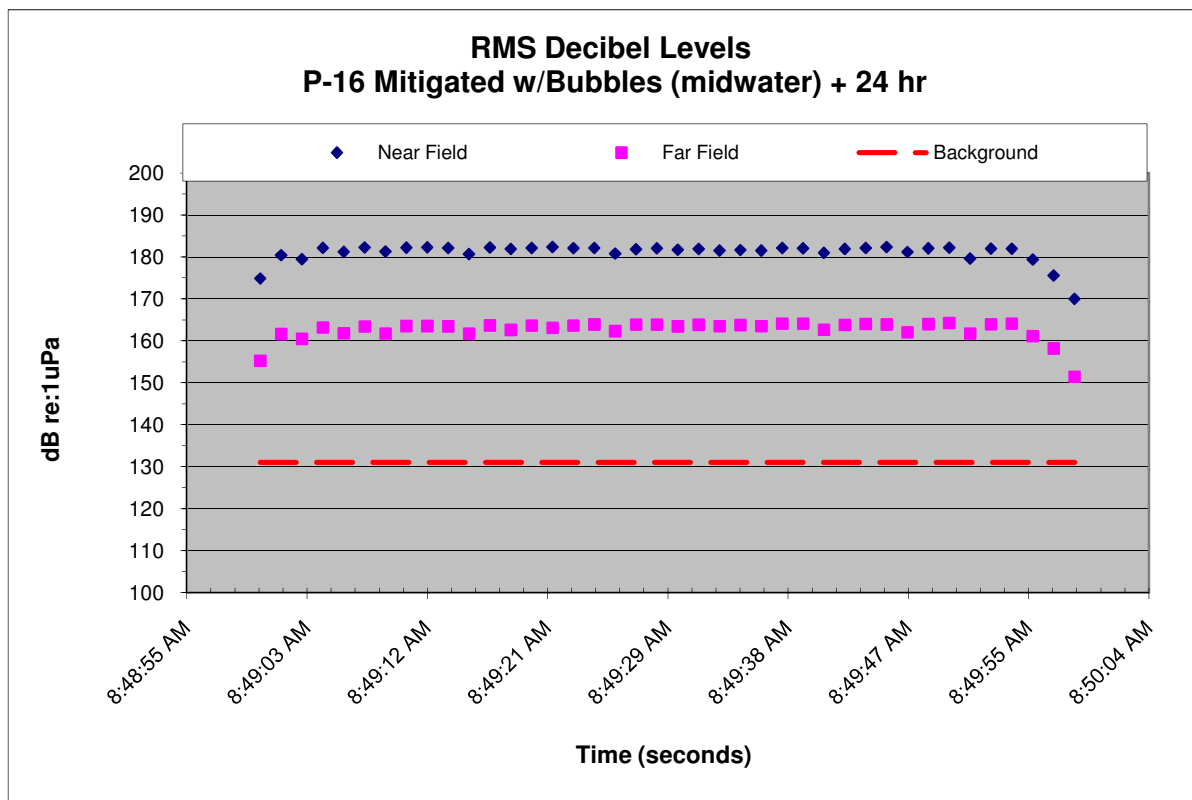

Figure 21: Pile P-16 (midwater) - Comparison of mitigated Root Mean Square values (RMS) for individual hammer strikes at 15 meters (near field) and 754 meters (far field) from the pile after a 24-hour period. Average background RMS values are also included.

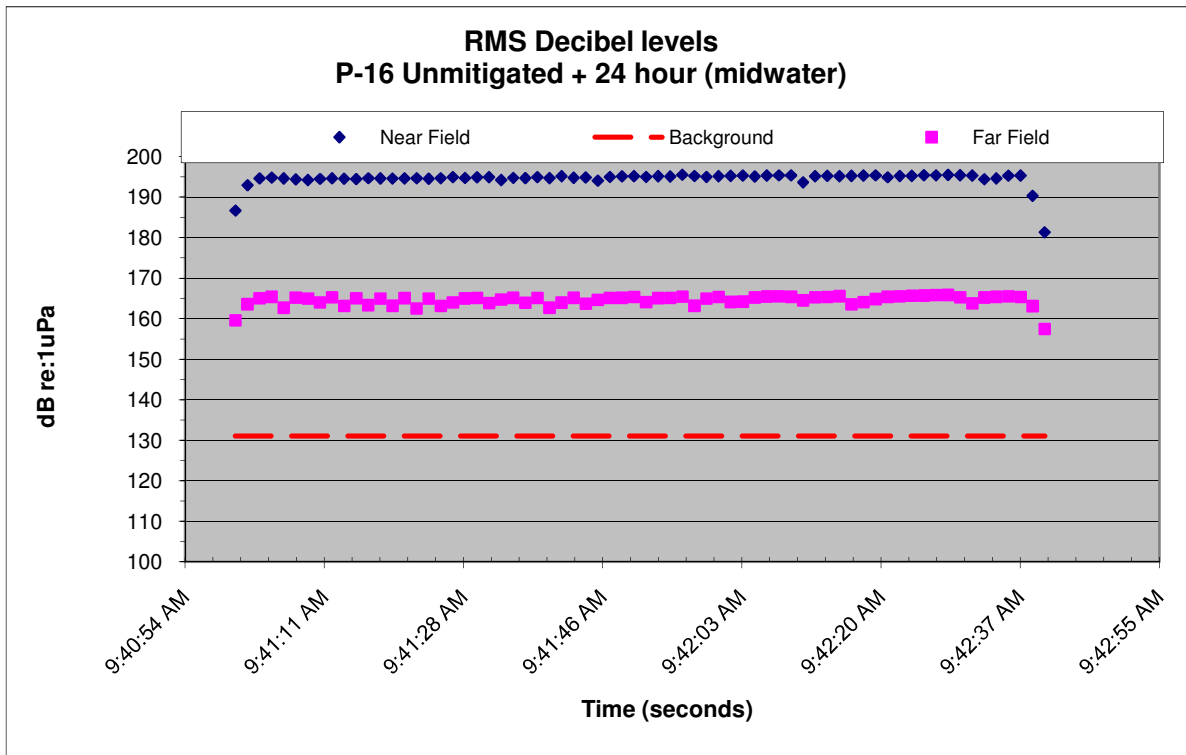

Figure 22: Pile P-16 (midwater) - Comparison of unmitigated Root Mean Square values (RMS) for individual hammer strikes at 15 meters (near field) and 754 meters (far field) from the pile. Average Background RMS values are also included.

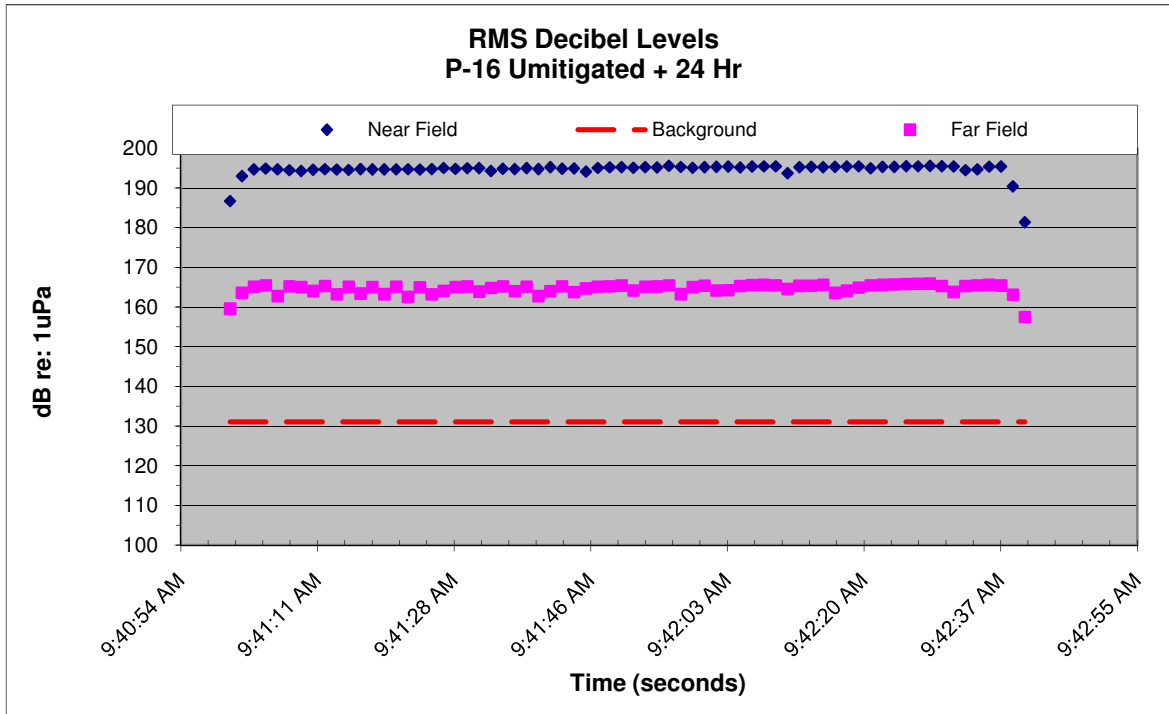

Figure 23: Pile P-16 (bottom) - Comparison of unmitigated Root Mean Square values (RMS) for individual hammer strikes at 15 meters (near field) and 754 meters (far field) from the pile. Average Background RMS values are also included.

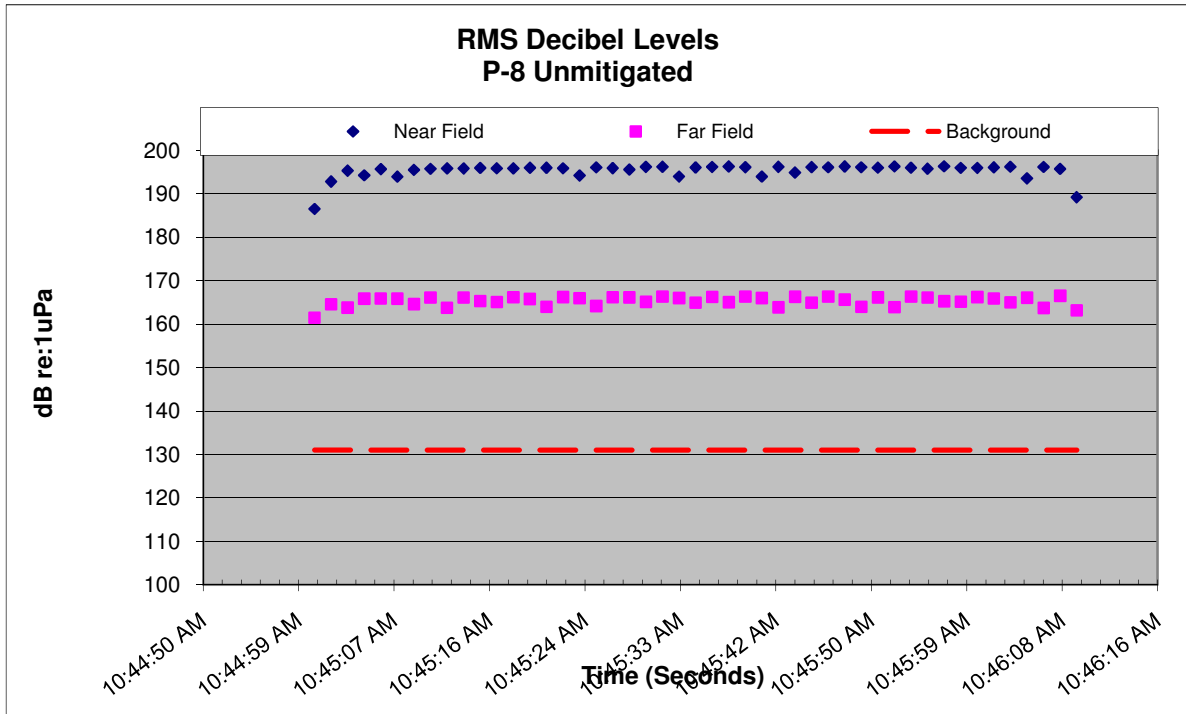

Figure 24: Pile P-8 (bottom) - Comparison of unmitigated Root Mean Square values (RMS) for individual hammer strikes at 16 meters (near field) and 754 meters (far field) from the pile. Average background RMS values are also included.

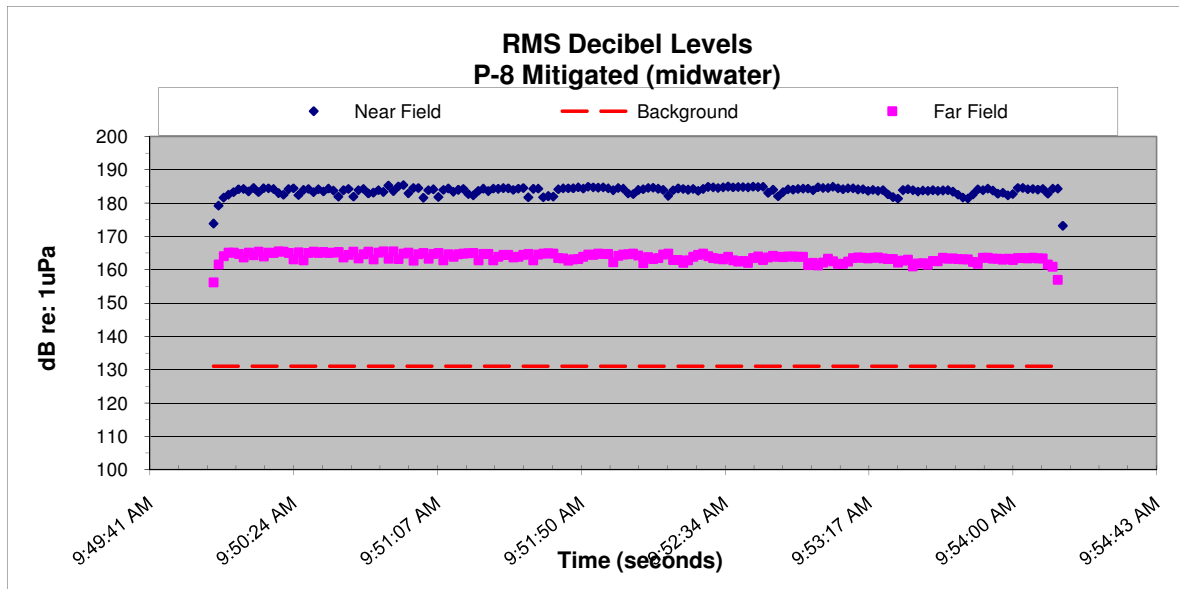

Figure 25: Pile P-8 (midwater) - Comparison of unmitigated Root Mean Square values (RMS) for individual hammer strikes at 16 meters (near field) and 754 meters (far field) from the pile. Average background RMS values are also included.

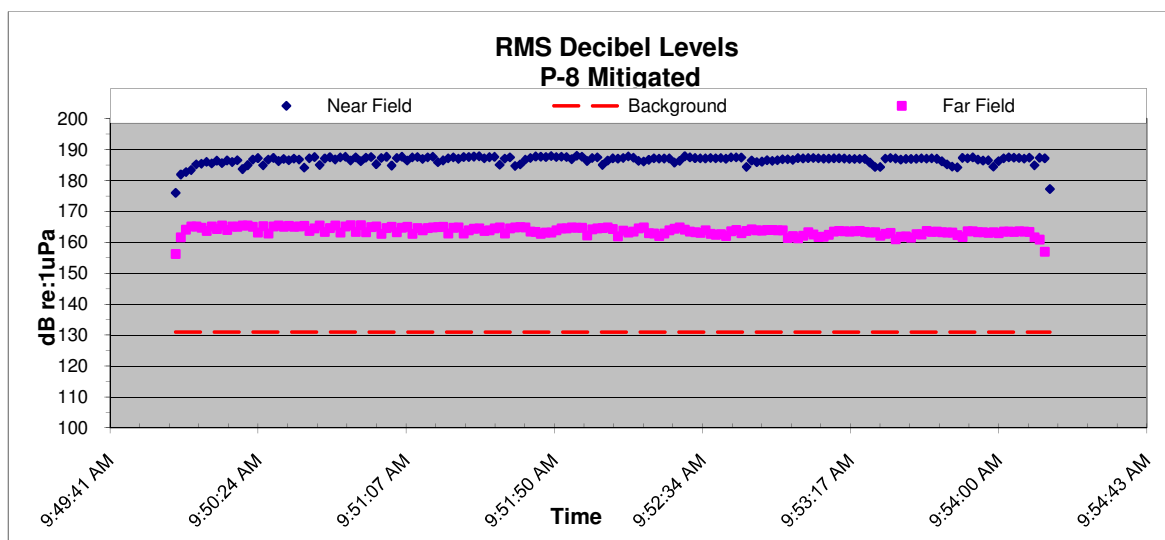

Figure 26: Pile P-8 (bottom) - Comparison of mitigated Root Mean Square values (RMS) for individual hammer strikes at 16 meters (near field) and 754 meters (far field) from the pile. Average background RMS values are also included.

BACKGROUND MEASUREMENTS

Measurements of broadband background levels indicate that the average background RMS level measured during the same hours that pile driving occurred but without the pile driving activity ranged between 123 dB RMS and 131 dB RMS with an overall average of 128 dB RMS. Therefore, the practical spreading model calculates the distance for the highest unmitigated impact pile driving noise levels measured at 7 meters from the pile at 195 dB RMS to reach the 128 dB RMS background in 291 miles (Figure 27).

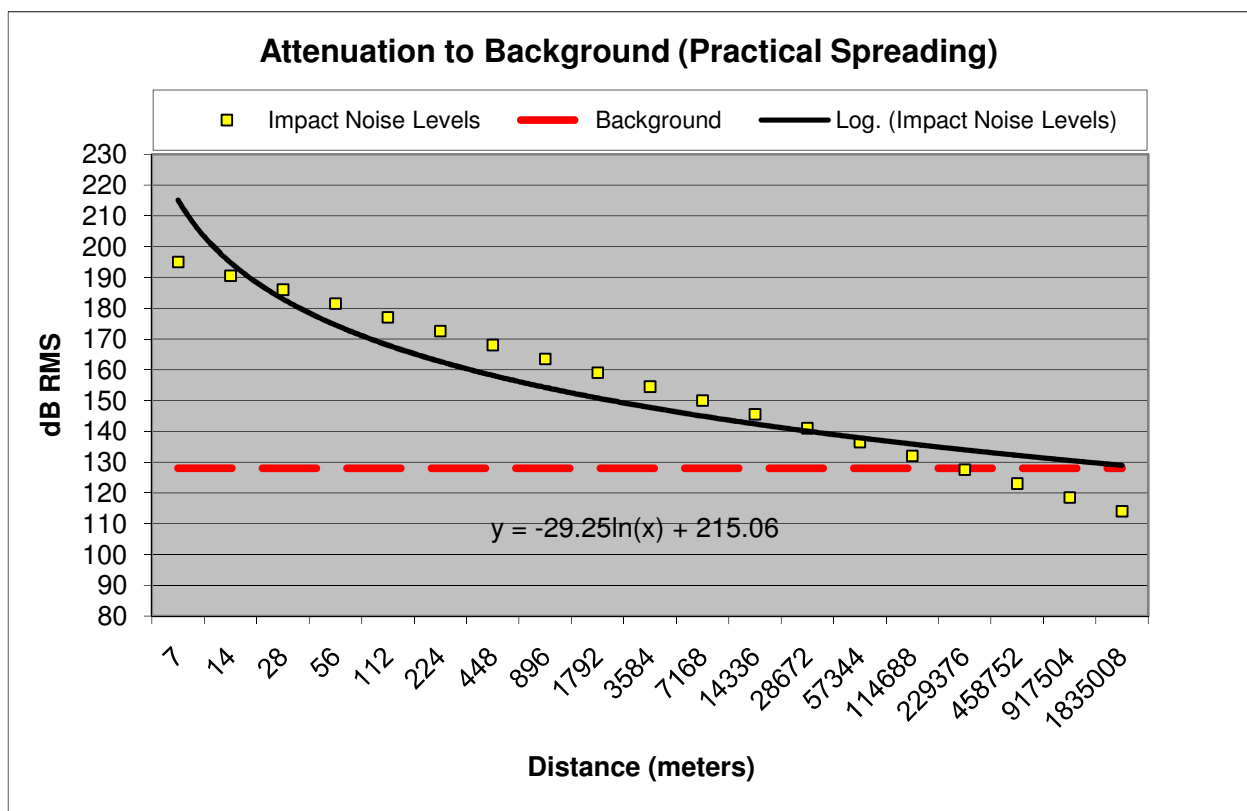

Figure 27: Graphical representation of attenuation of the 195 dB RMS value at the source and at what distance it would attenuate to background using the practical spreading model at the Vashon Ferry Terminal.

Figure 28 indicates that when using the spherical spreading model the same impact noise levels at the source would attenuate to 128 dB RMS background at 9 miles. Based on the findings in Table 4 above it would seem that it is more likely that the sound would attenuate to background well before the 291 miles predicted by the practical spreading model and more likely closer to the 9 miles predicted by the spherical spreading model.

However, care should be taken to consider differences in the acoustic environment when extrapolating propagation loss estimates from the Vashon Ferry terminal site to other locations. The water depth at the pile driving site was relatively shallow (30-40 feet) and the bathymetry was characterized by a steeply sloping bottom that dropped away rapidly in the offshore direction at a rate of approximately 25 meters depth per 100 meters distance from shore (~14 degrees slope). As with all empirically derived transmission loss laws, the spherical spreading law suggested for the Vashon site should only be extrapolated to similar acoustic propagation environments.

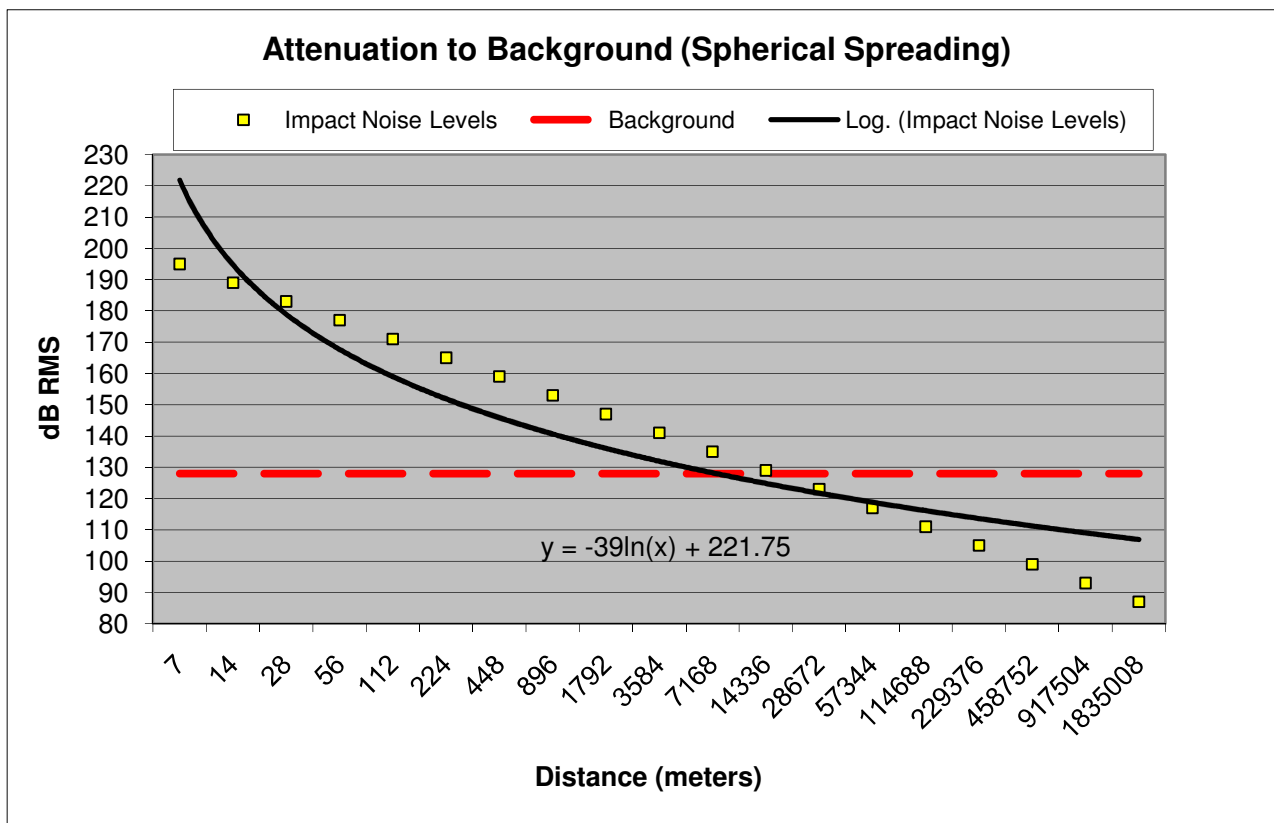

Figure 28: Graphical representation of attenuation of the 195 dB RMS value at the source and at what distance it would attenuate to background using the spherical spreading model at the Vashon Ferry Terminal.

Background noise measurements were collected for a 48-hour period. The first 24-hours of data are presented in this report. Table 5 lists the hourly average background noise levels one half mile from the terminal. The hourly values range from 117 dB RMS to 137 dB RMS. The background noise levels in this location are dominated by ferry vessel sound levels and show a strong correlation to the arrival and departure schedule of the ferries at the terminal.

Table 5: Hourly average background RMS values for the Vashon ferry terminal.

Hourly RMS Background Values		
Time	Pascals	dB
11:00 AM	4.05	132.2
12:00 PM	3.46	130.8
1:00 PM	2.76	128.8
2:00 PM	4.01	132.1
3:00 PM	7.08	137.0
4:00 PM	4.23	132.5
5:00 PM	3.65	131.3
6:00 PM	4.35	132.8
7:00 PM	4.63	133.3
8:00 PM	4.24	132.5
9:00 PM	3.44	130.7
10:00 PM	4.73	133.5
11:00 PM	1.39	122.9
12:00 AM	0.69	116.9
1:00 AM	1.82	125.2
2:00 AM	1.55	123.8
3:00 AM	1.86	125.4
4:00 AM	3.31	130.4
5:00 AM	2.75	128.8
6:00 AM	3.26	130.3
7:00 AM	5.89	135.4
8:00 AM	3.67	131.3
9:00 AM	2.30	127.3
10:00 AM	4.59	133.2
11:00 AM	4.43	132.9
Avg. of All Hours	3.53	130.9

Figure 29 is a graphical representation of the data from Table 5 above. The figure indicates that the background sound levels during the typical daytime hours when pile driving would occur are relatively consistent between 130 dB and 135 dB RMS. It is only during the nighttime hours between 12 AM and 2 AM that the background sound levels drop off to below 120 dB RMS due to the relative lack of ferry and other marine traffic during these hours.

Because the background sound levels in this area is dominated by ferry vessels and to a lesser degree by other marine traffic sources, it would be expected that the background sound levels would not vary substantially from day to day and would only see a noticeable change with a change in the ferry schedule.

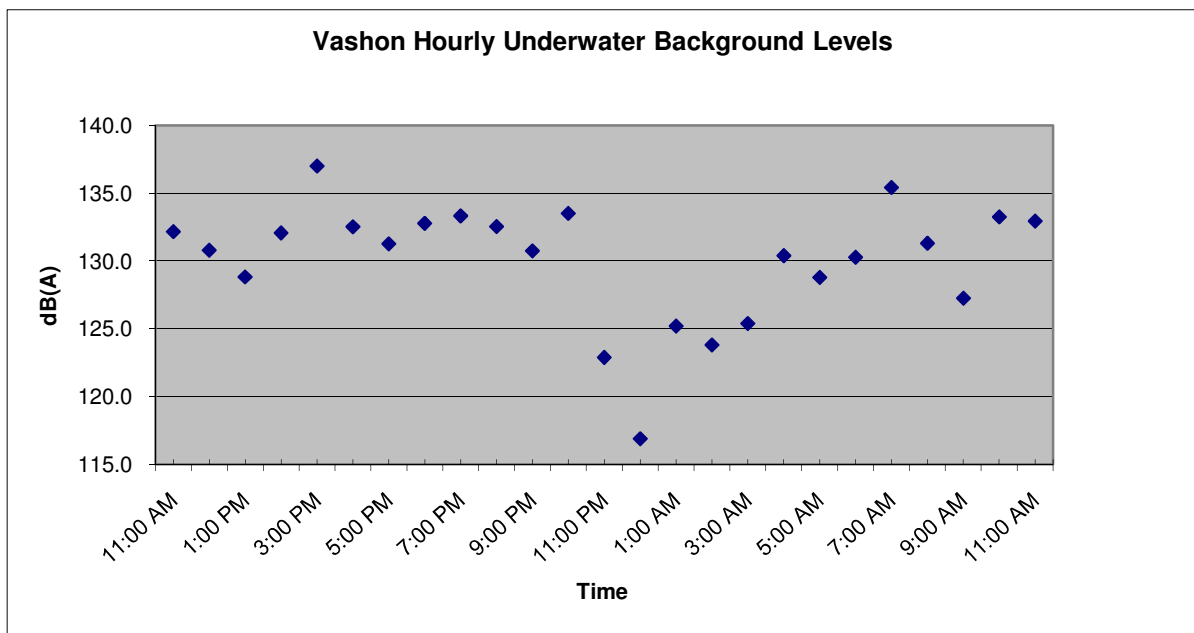

Figure 29: Graphical representation of hourly background noise levels (dB RMS) measured for a 24-hour period at the Vashon ferry terminal.

SEL

Single Strike SEL is calculated for the single highest absolute peak strike for each pile. Only pile P-14 mitigated with bubbles on was able to not exceed the current threshold of 187 dB SELcum with only 4 strikes under this scenario.

A total of 454 pile strikes for the first three of four steel piles driven on 11/17/09 generated a cumulative SEL of 210 dB_{SELcum} assuming a single strike SEL of 184 dB_{SEL} which was the highest single strike SEL calculated that day. A total of 326 pile strikes for the remaining steel pile on 11/18/09 generated a cumulative SEL of 211 dB_{SELcum} assuming a single strike SEL of 186 dB_{SEL} which was the highest calculated single strike SEL for the second day. Not all single strike SELs were at these levels and there were several breaks in pile driving lasting an hour or more each day.

Rise Time

Yelverton (1973) indicated rise time was the cause of injury. According to Yelverton (1973), the closer the peak is to the front of the impulse wave the greater the chance for injury. In other words, the shorter the rise time the higher the likelihood for effects on fish.

In all steel piles without effective mitigation the rise times were relatively short and those with mitigation had relatively long rise times. This could be an indication that the pile was ringing due to the relatively hard substrate or an indication of sound flanking where most of the energy was not traveling directly through the water but through the sediment up to the hydrophone. However, this relationship is not entirely clear.

CONCLUSIONS

The modified TNAP developed by the UW team provided an overall noise reduction of 11 decibels. There was only a slight improvement in noise reduction with the use of bubbles on the inside of the TNAP. The UW team is currently developing their own analyses and report that will hopefully provide insight as to why the TNAP was not as effective as originally modeled and what our next steps might be to improve our mitigation strategies.

Remote underwater measurements made at 0.46 miles from the pile driving activity using the AMAR indicate that there is an average transmission loss of 32 dB over that distance. It is also recommended that the spherical spreading loss model be used in this location as it is more accurate than the practical spreading model.

As a result of these tests, it is recommended that TNAP could be used as an alternative to the bubble curtain as an underwater noise mitigation device, however, a simple confined bubble curtain might provide better attenuation.

REFERENCES

Yelverton, John T., Donald R. Richmond, E. Royce Fletcher, and Robert K. Jones. 1973. Safe Distances from Underwater Explosions for Mammals and Birds. Lovelace Foundation for Medical Education and Research AD-766 952, Prepared for Defense Nuclear Agency.

APPENDIX A- STEEL PILE WAVEFORM ANALYSIS FIGURES

PILE P-14 – NO MITIGATION

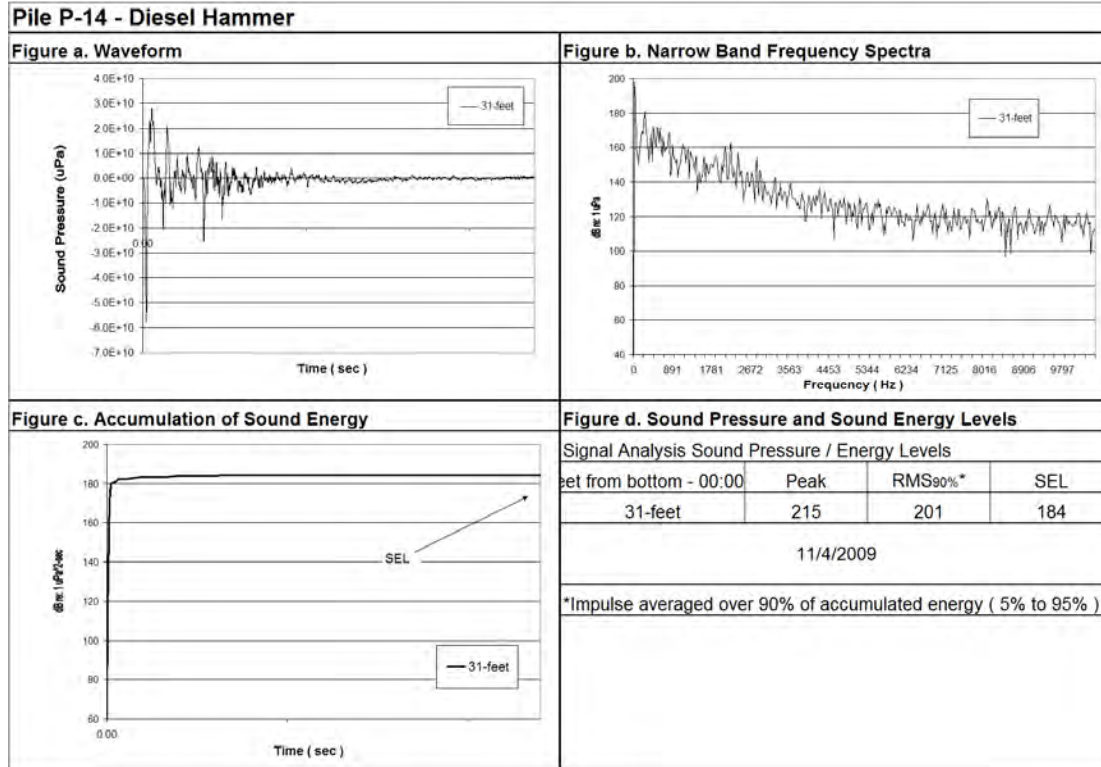

Figure 30: Waveform Analysis of Pile P-14 Sound Pressure Levels without mitigation, 3 feet from the bottom (no data for midwater hydrophone).

PILE P-14 – WITH MITIGATION

Figure 31a

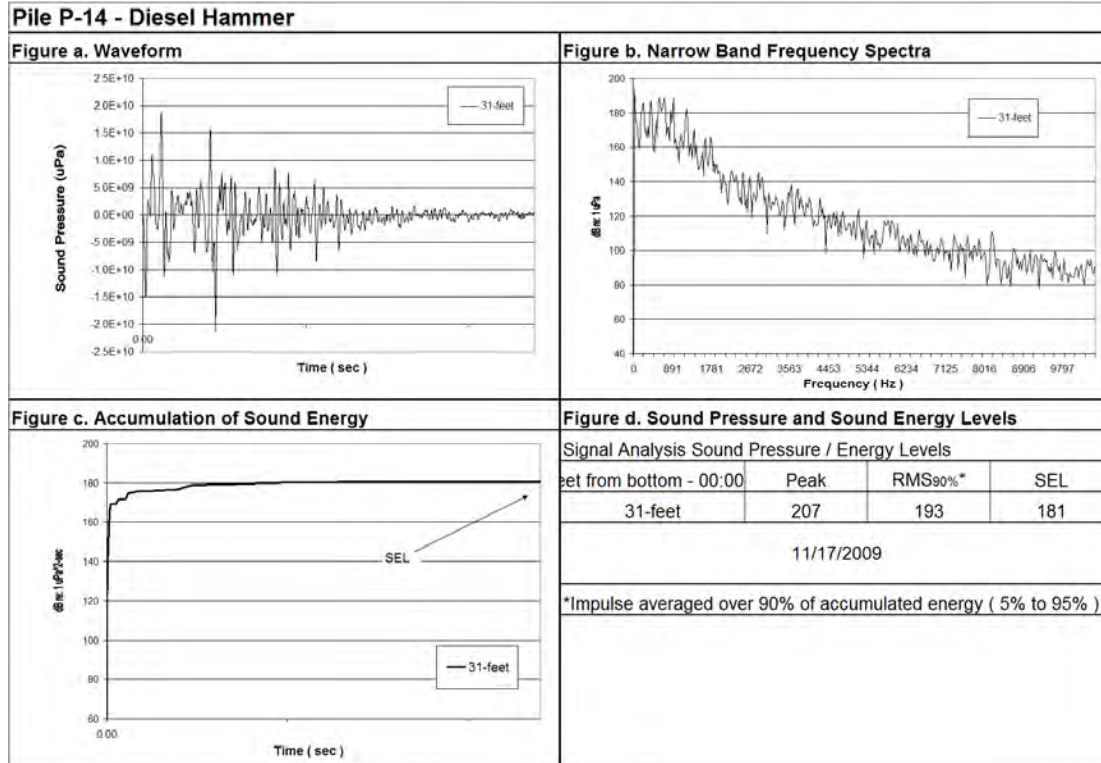

Figure 31b

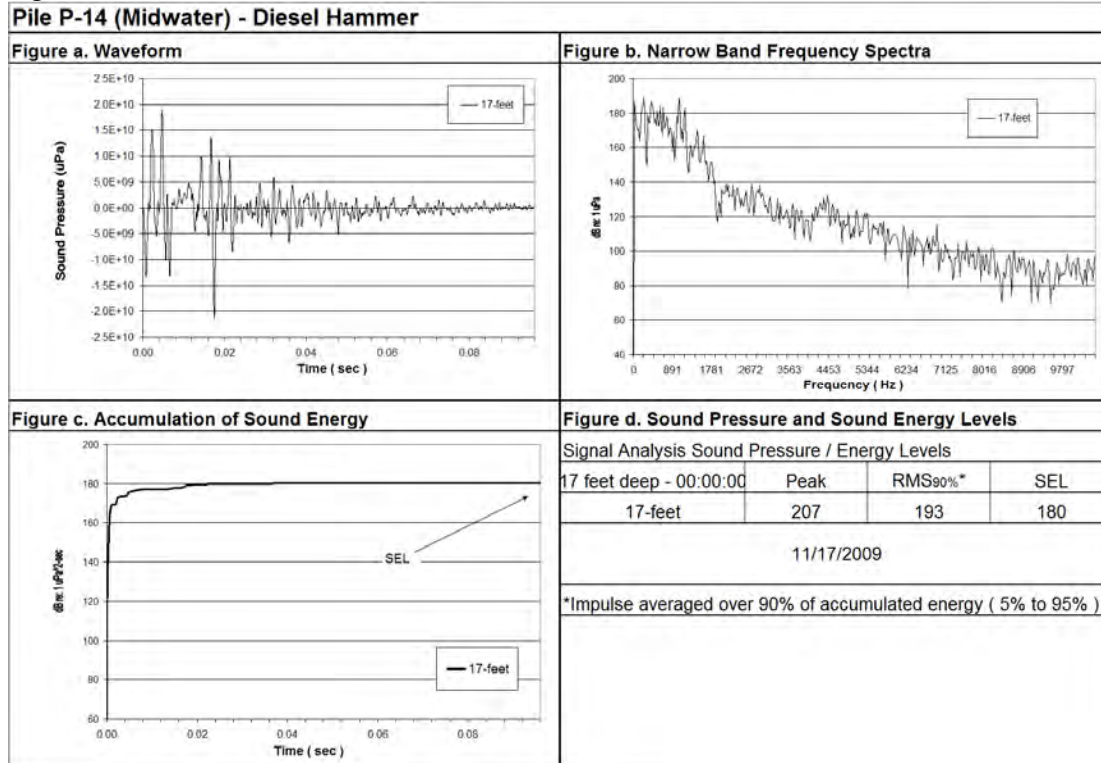

Figure 31: Waveform Analysis of Pile P-14 Sound Pressure Levels with mitigation 1 meter from the bottom (a) and midwater (b).

PILE P-14 – WITH MITIGATION + BUBBLES

Figure 32a

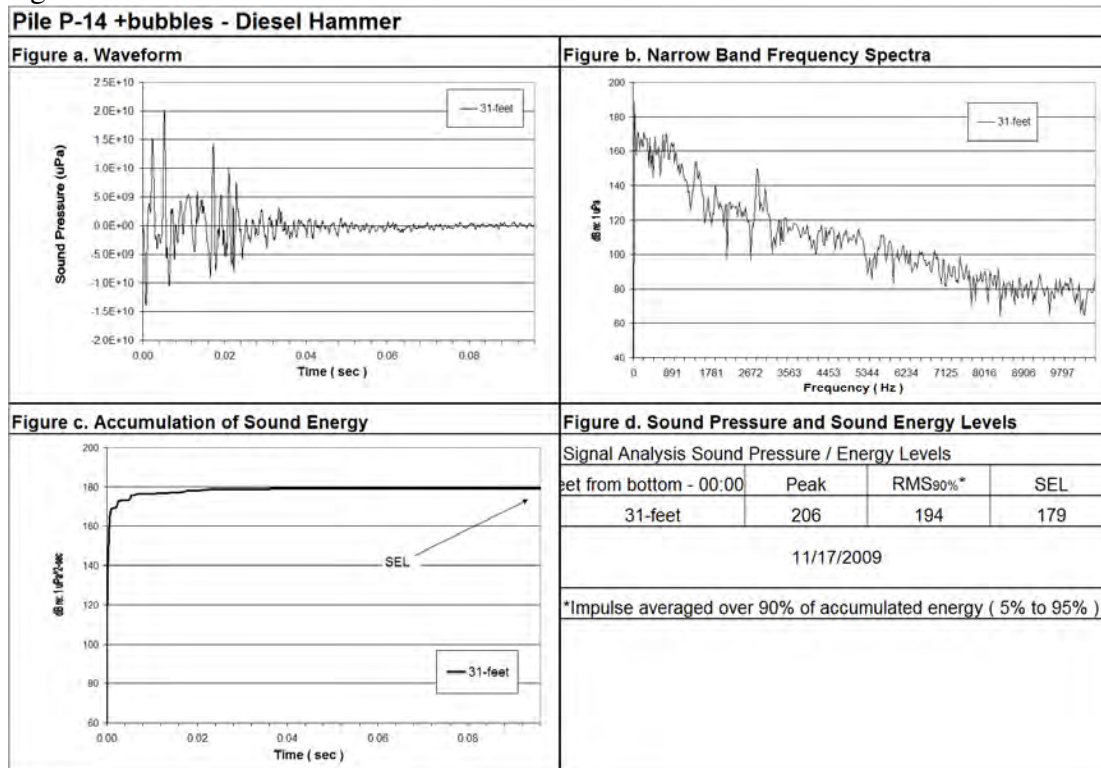

Figure 32b

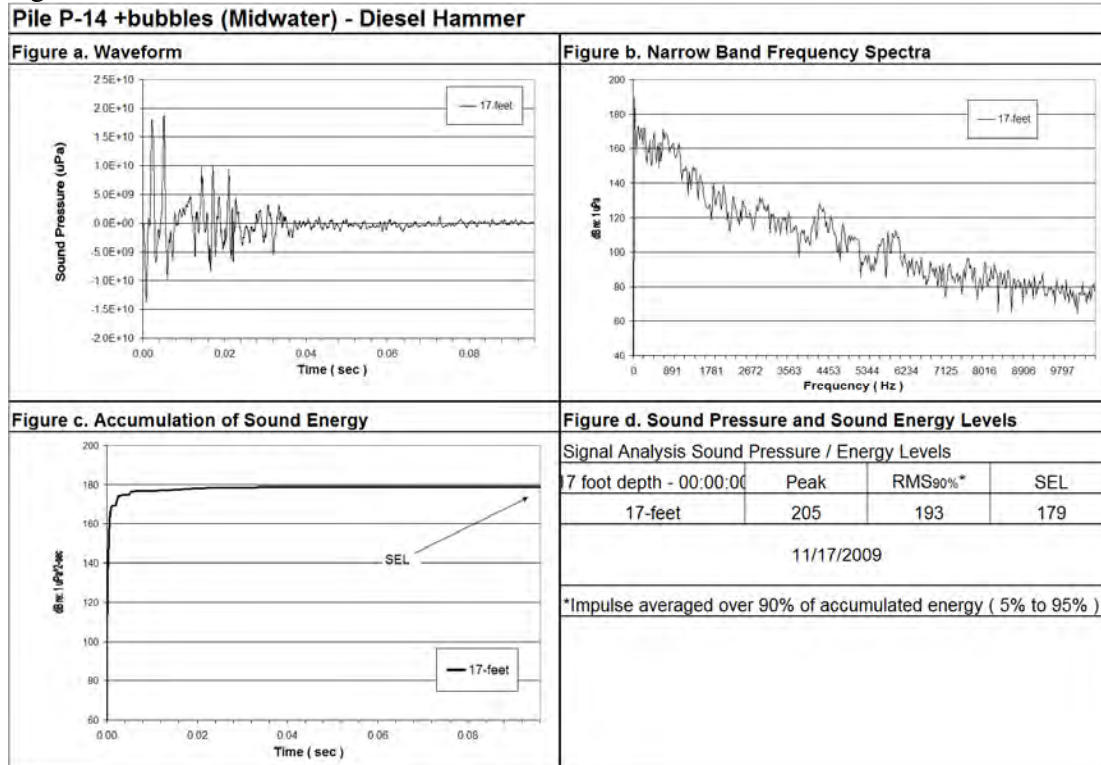

Figure 32: Waveform Analysis of Pile P-14 Sound Pressure Levels with Temporary Noise Attenuation Pile (TNAP) and bubbles, midwater.

PILE P-10 – WITH MITIGATION + BUBBLES

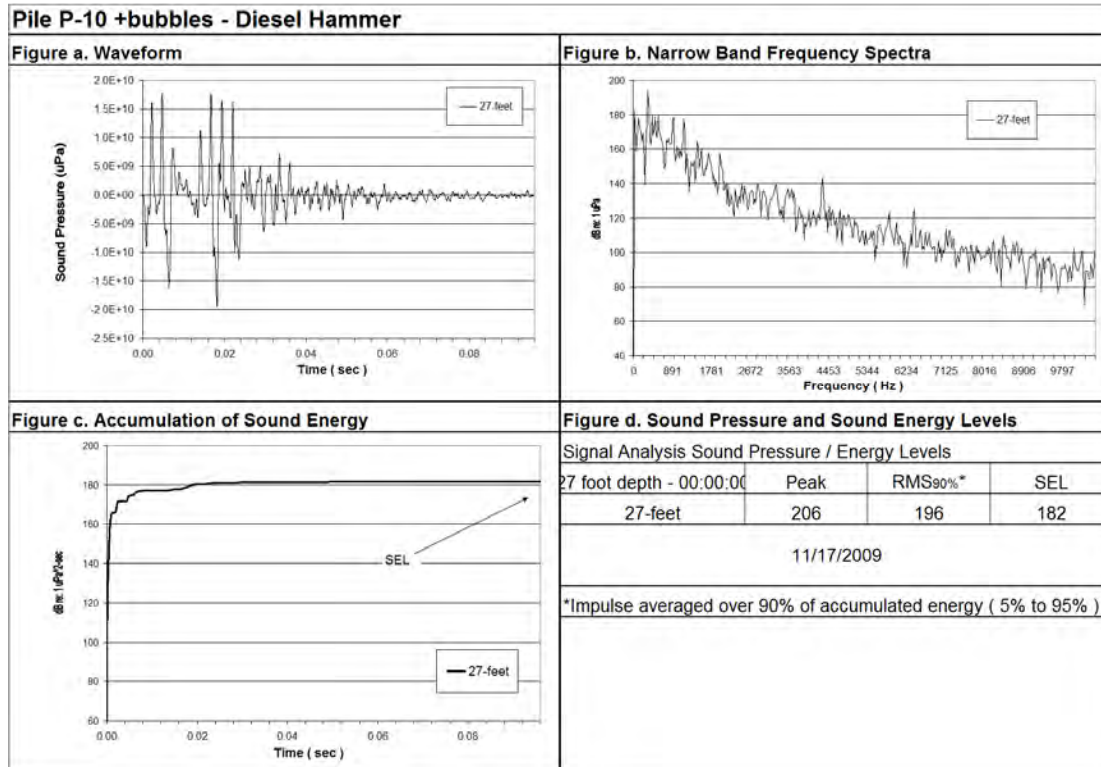

Figure 33: Waveform Analysis of Pile P-10 Sound Pressure Levels with TNAP, Midwater.

PILE P-16 – UNMITIGATED + 24 HRS

Figure 34a

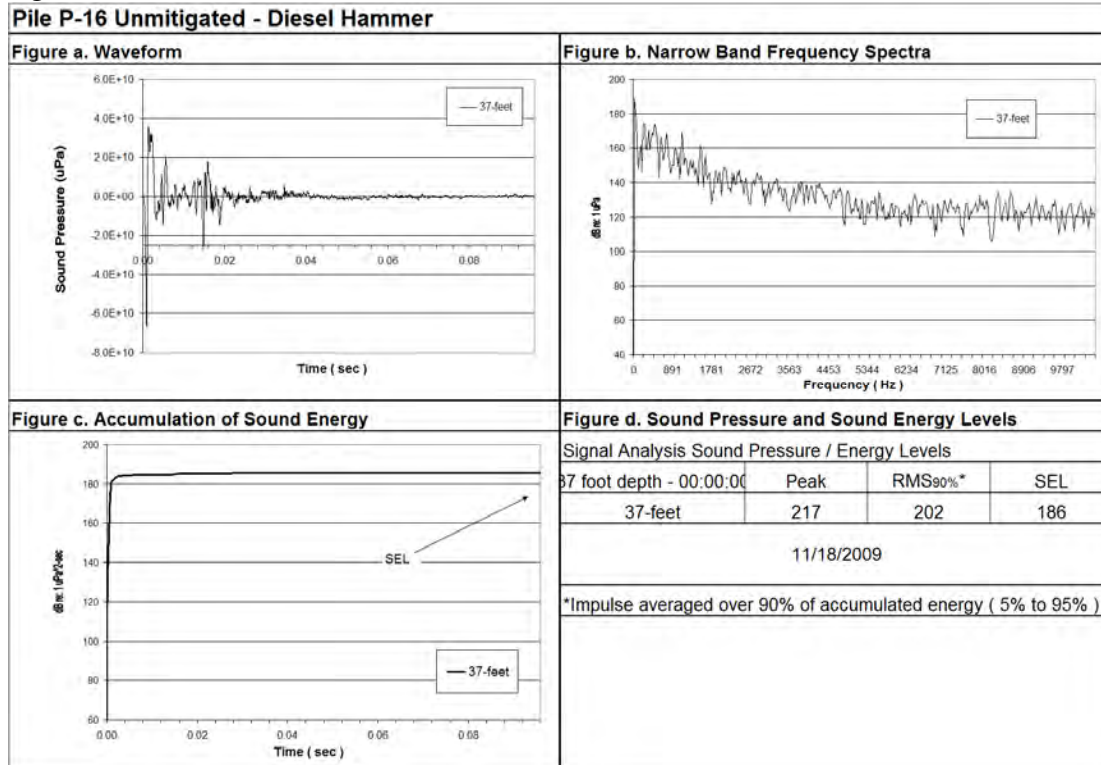

Figure 34b

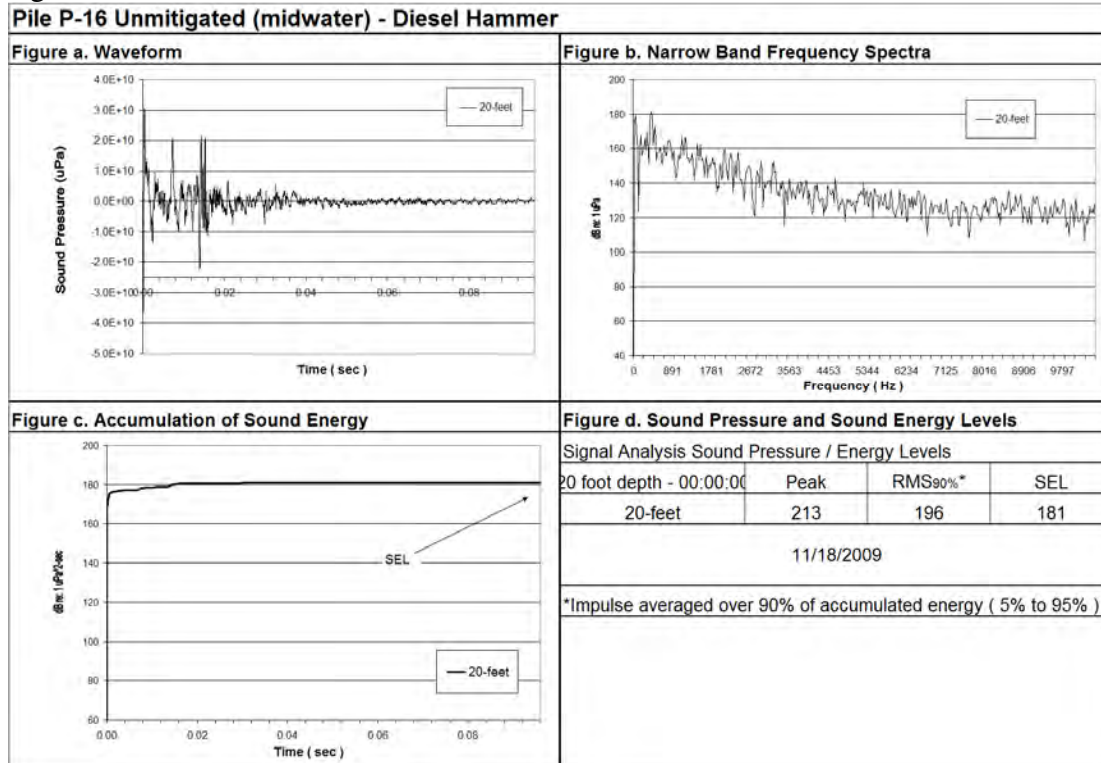

Figure 34: Waveform Analysis of Pile P-16 Sound Pressure Levels Unmitigated after setting for 24-hours, bottom (a) and midwater (b).

PILE P-16 – MITIGATION AND MITIGATION + BUBBLES

Figure 35a

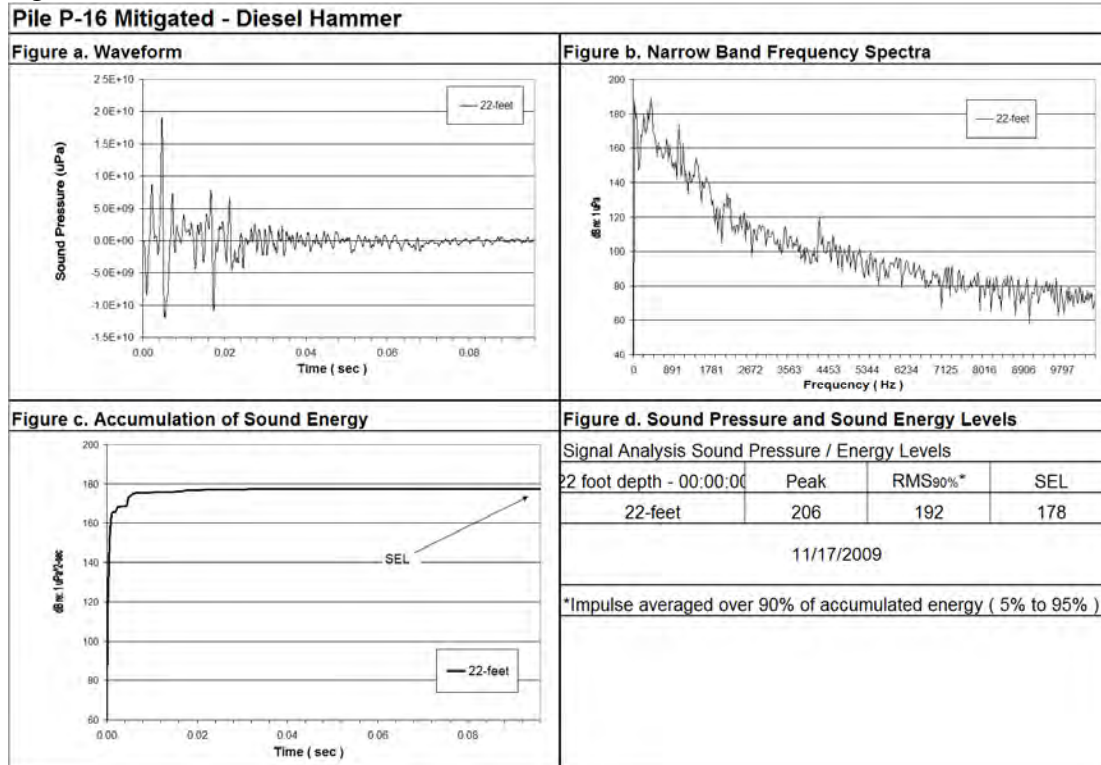

Figure 35b

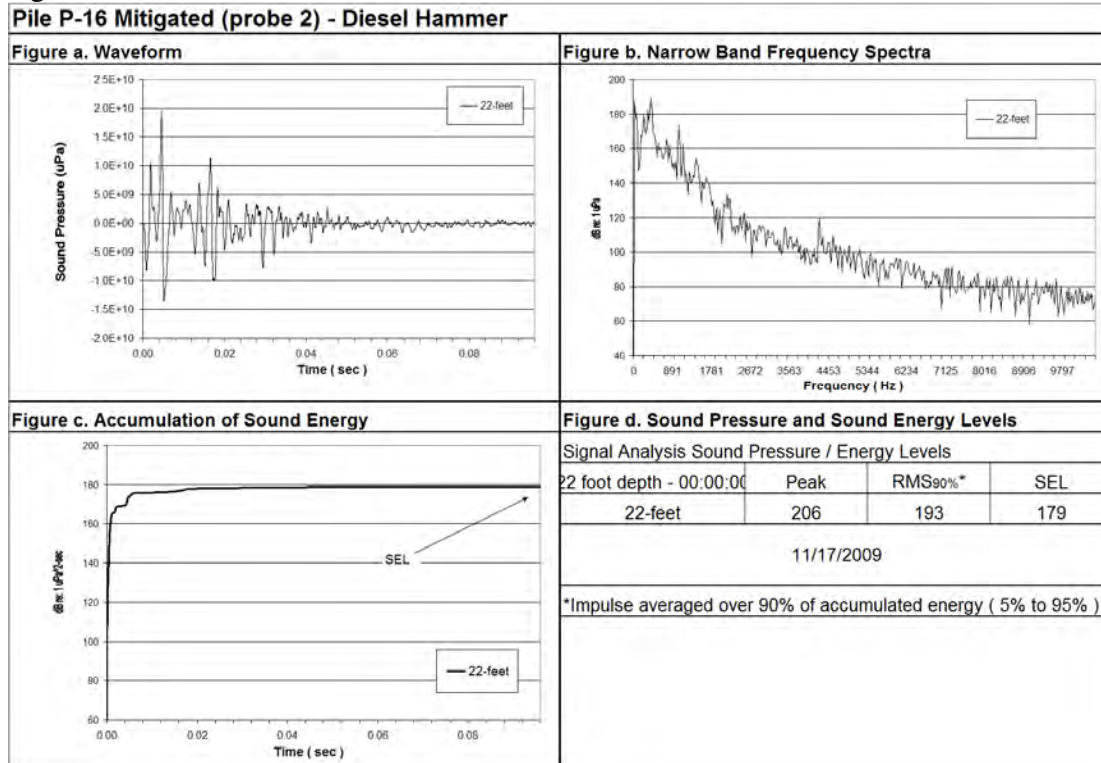

Figure 35c

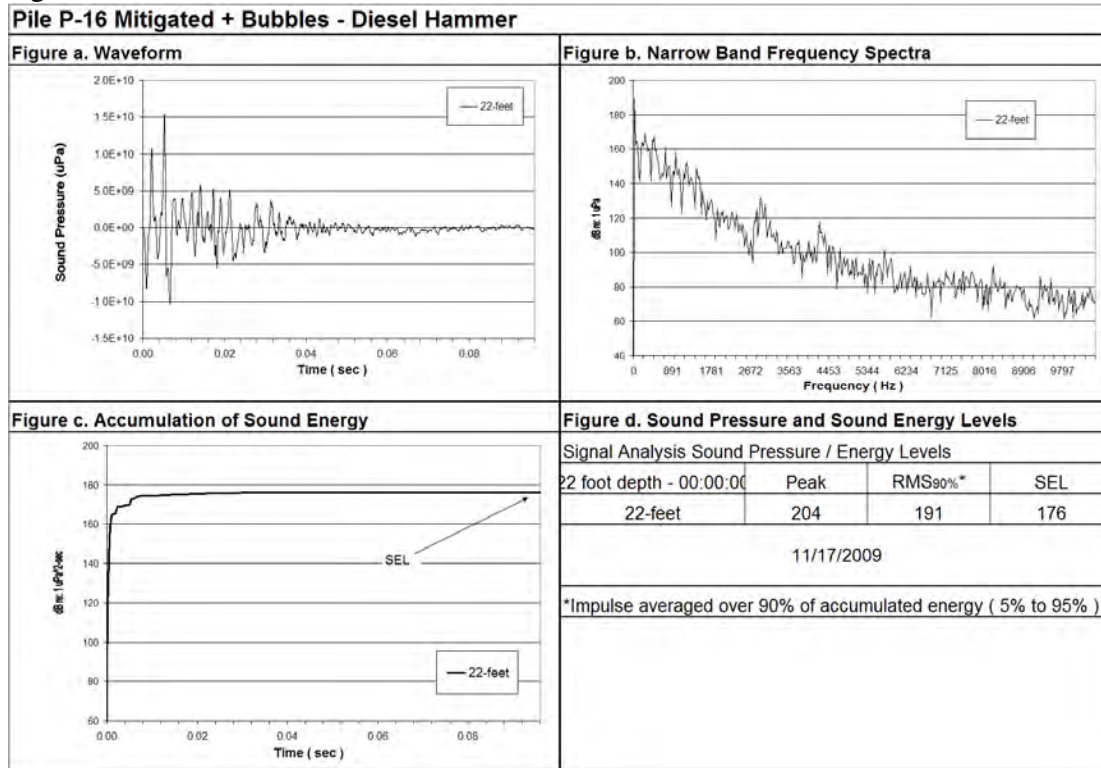

Figure 35d

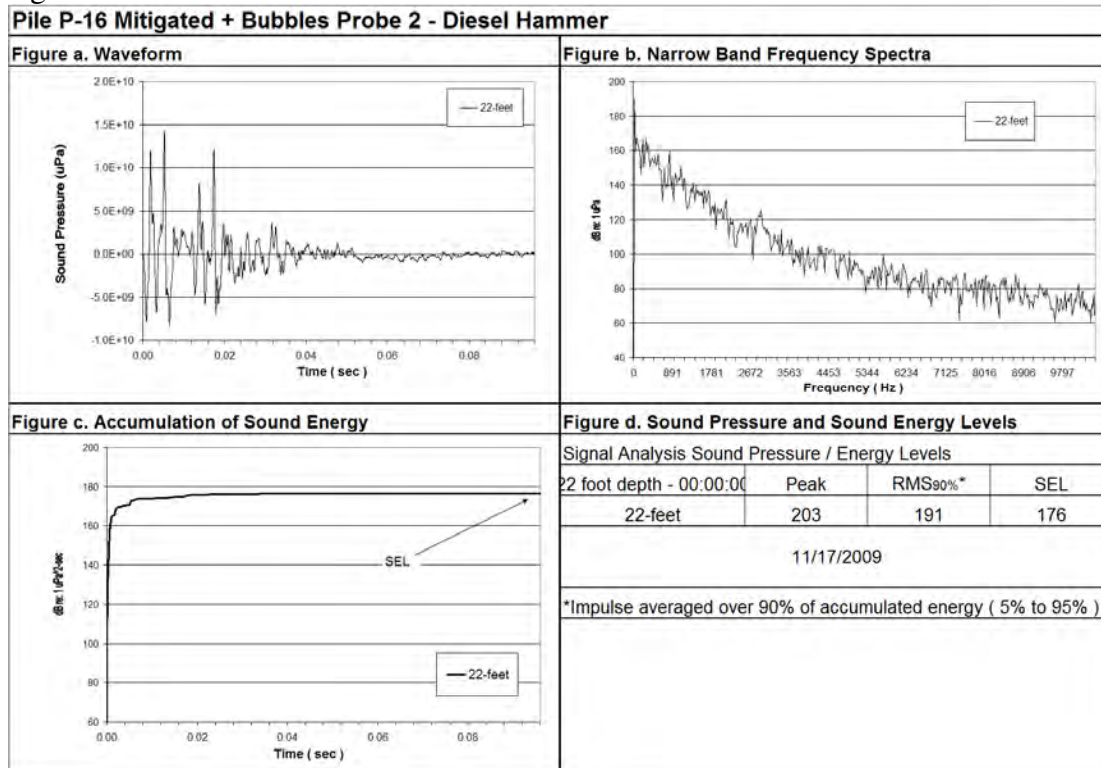

Figure 35: Waveform Analysis of Pile P-16 Sound Pressure Levels with Mitigation, bottom (a) and second hydrophone on bottom (b). Mitigated with bubbles on bottom (c) and second hydrophone on bottom (d).

PILE P-16 – MITIGATION + BUBBLES AFTER 24 HRS

Figure 36a

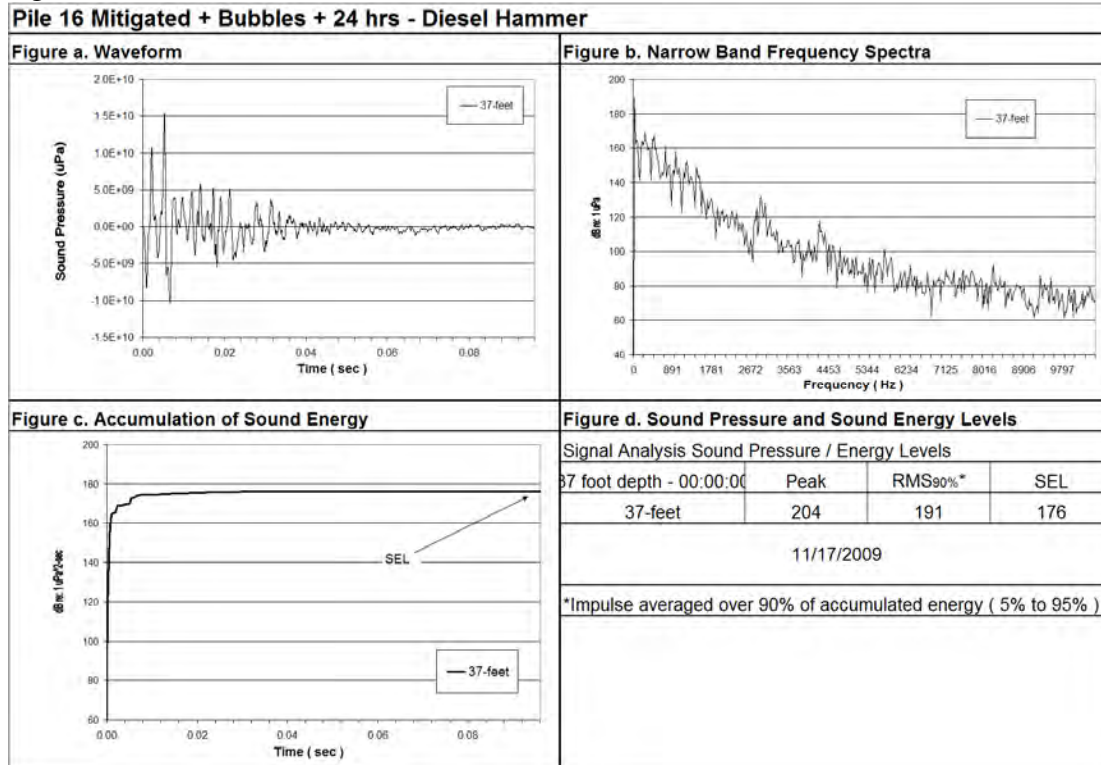

Figure 36b

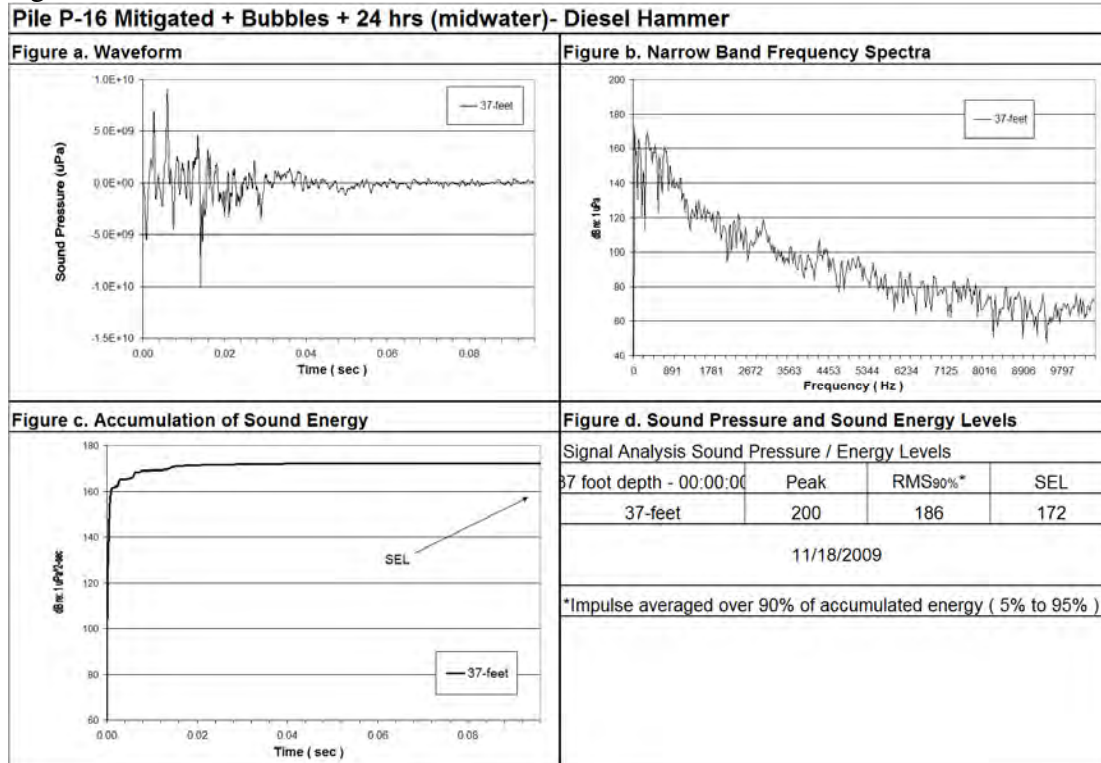

Figure 36: Waveform Analysis of Pile P-16 Sound Pressure Levels with mitigation and bubbles after setting for a 24-hour period, bottom (a) and midwater (b).

PILE P-8 UNMITIGATED

Figure 37a

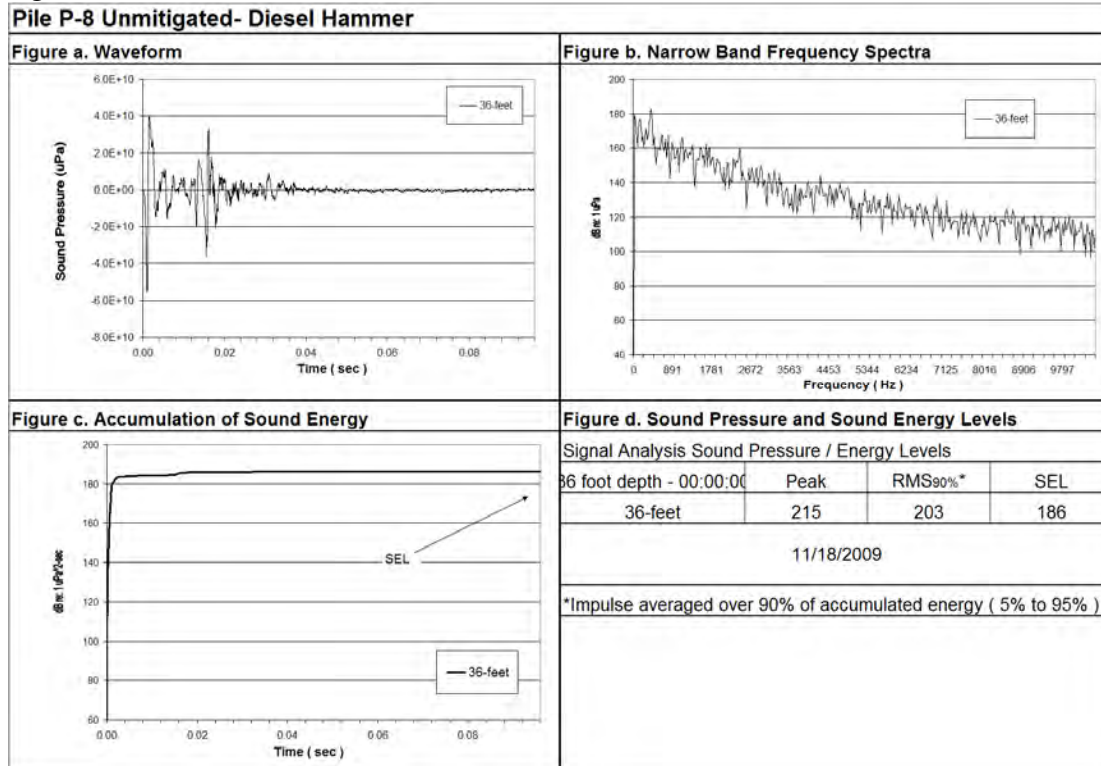

Figure 37b

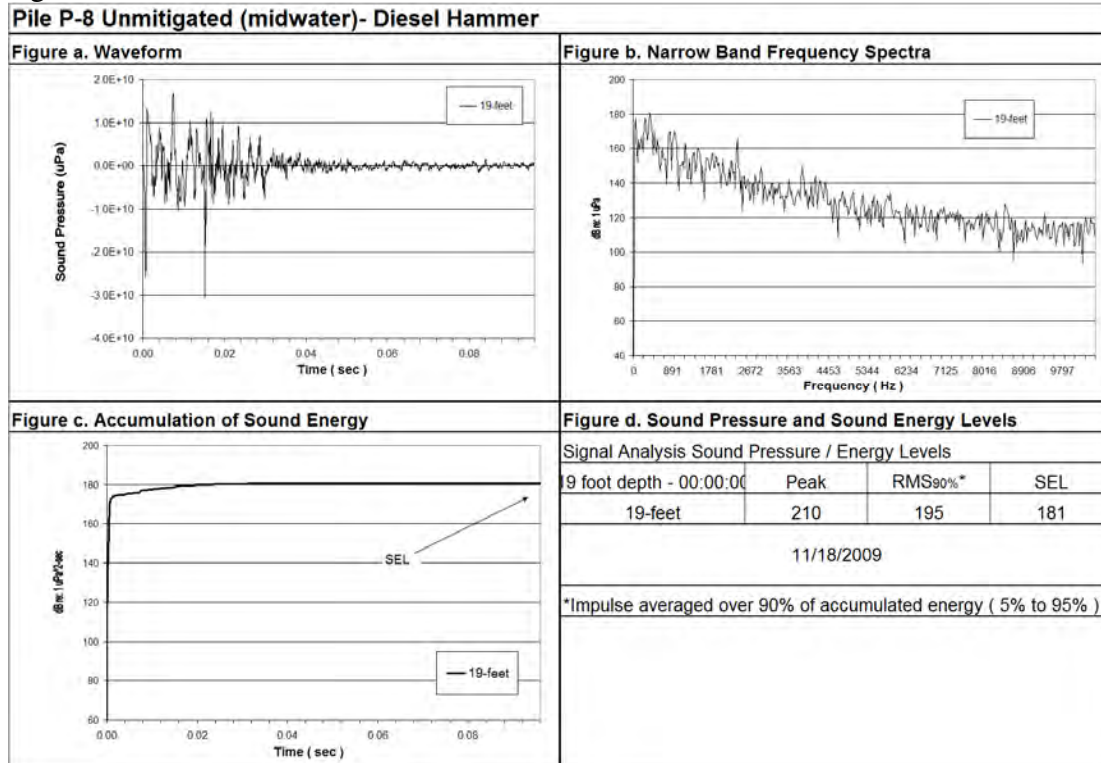

Figure 37: Waveform Analysis of Pile Number P-8 Unmitigated Sound Pressure Levels bottom (a) and midwater (b).

PILE P-8 - MITIGATED

Figure 38a

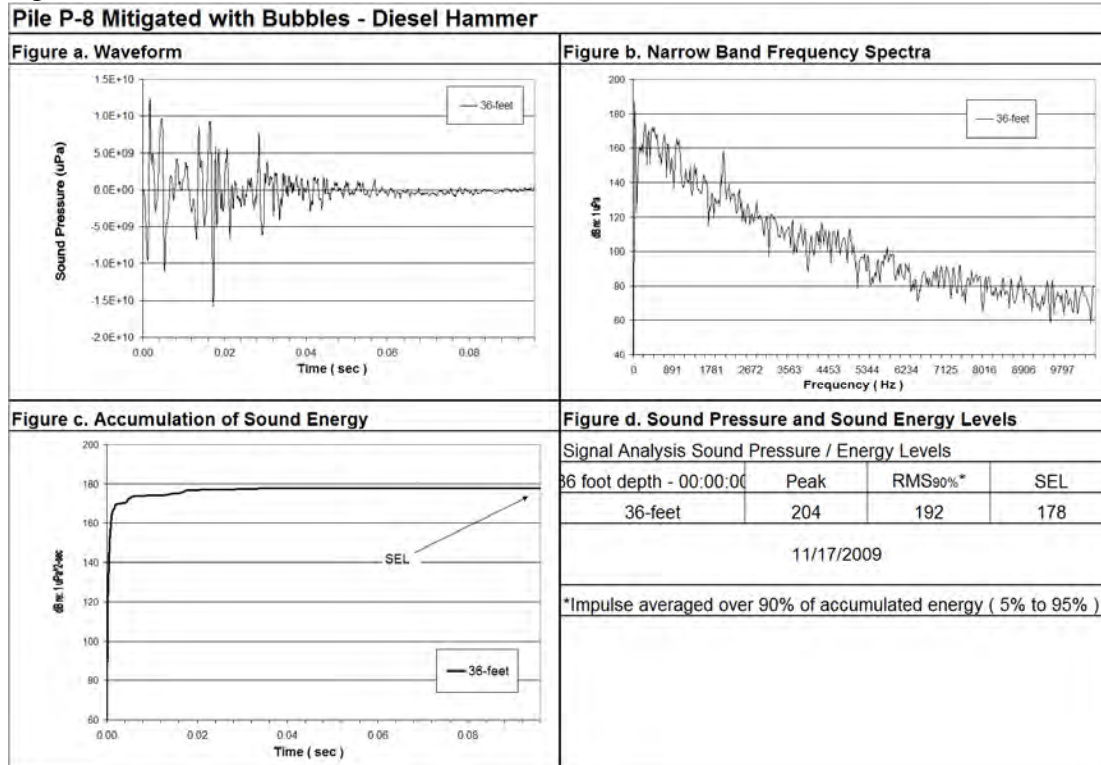

Figure 38a

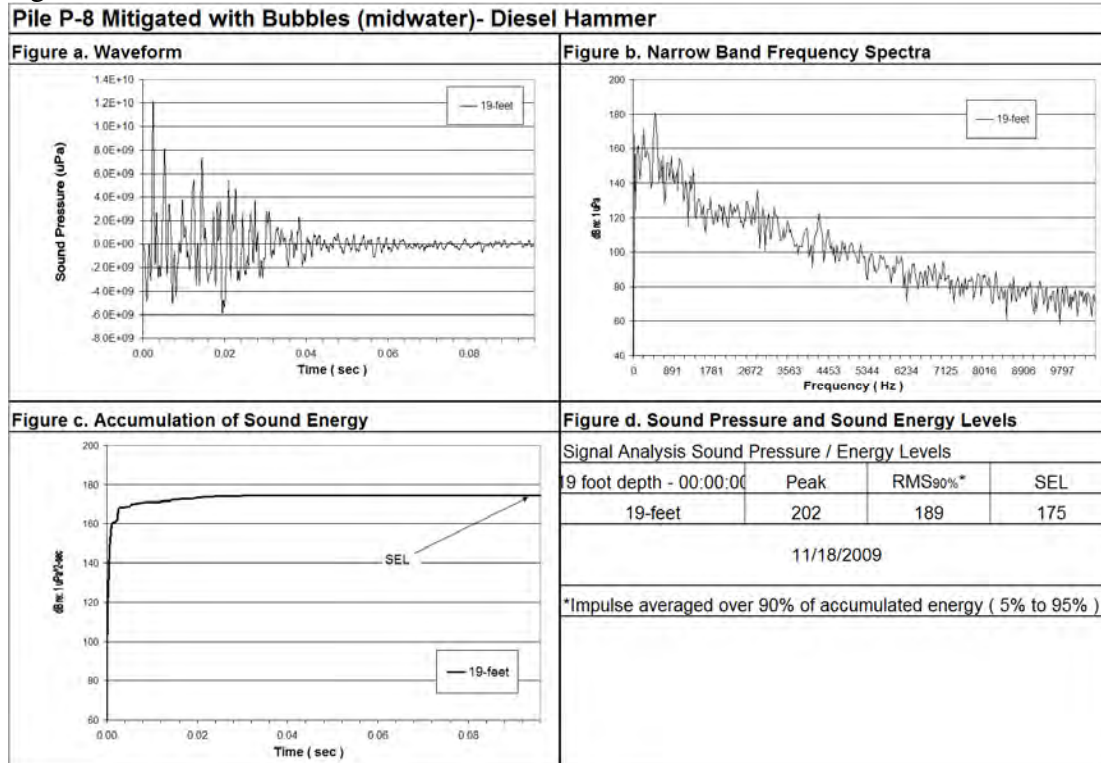

Figure 38: Waveform Analysis of Pile Number P-8 Mitigated with Bubble Sound Pressure Levels bottom (a) and midwater (b)..

APPENDIX B- STEEL PILE WAVEFORM ANALYSIS FIGURES FROM THE AMAR MINI

PILE P-14 - MITIGATED

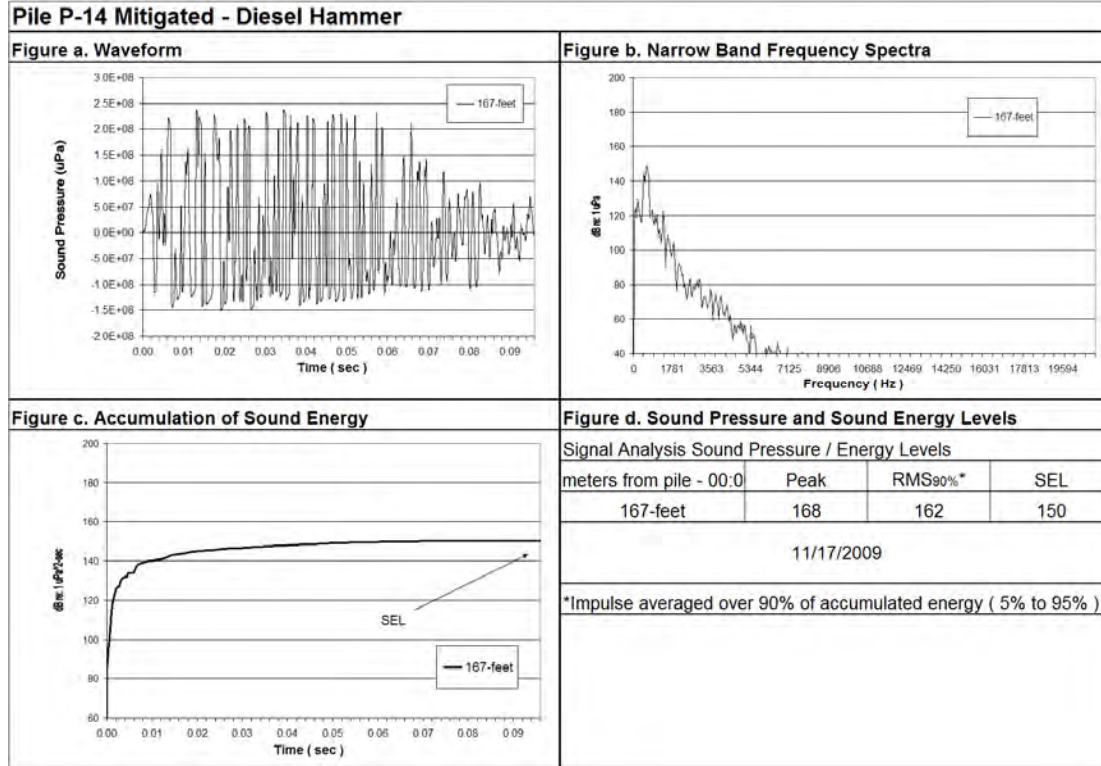

Figure 39: Waveform Analysis of Pile Number P-14 Mitigated Sound Pressure Levels 754 meters from the pile.

PILE P-14 - MITIGATED + BUBBLES

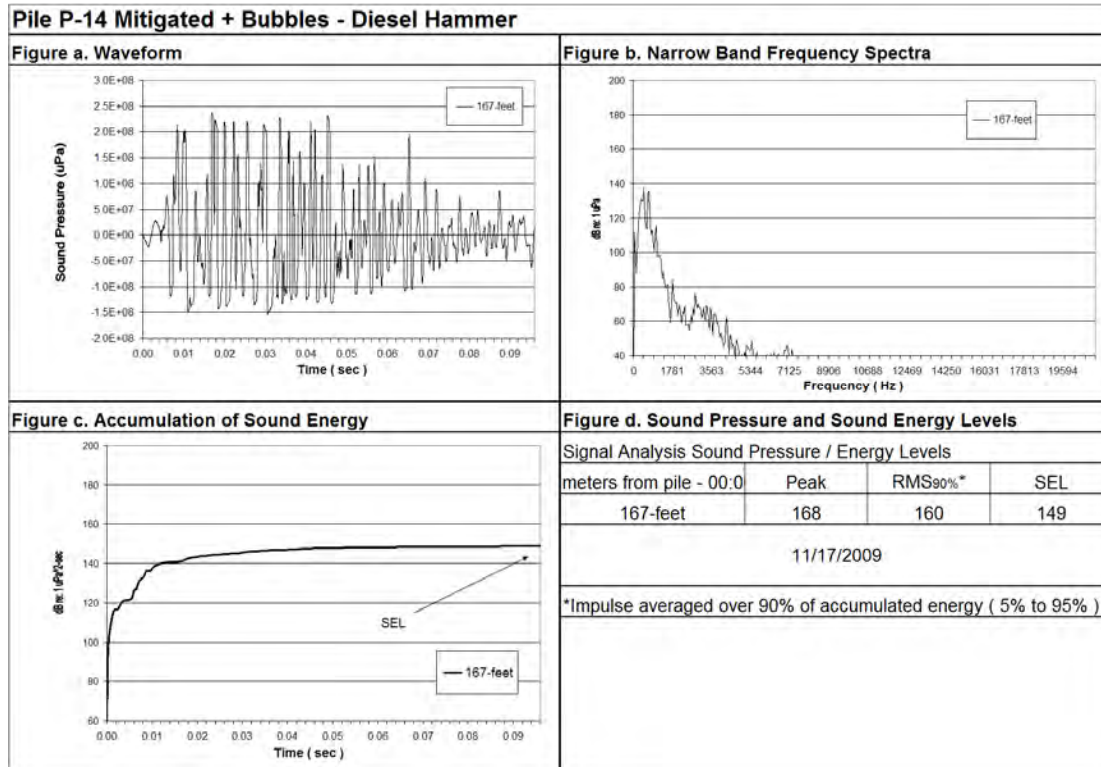

Figure 40: Waveform Analysis of Pile Number P-14 Mitigated with Bubbles Sound Pressure Levels 754 meters from the pile.

PILE P-14 - UNMITIGATED

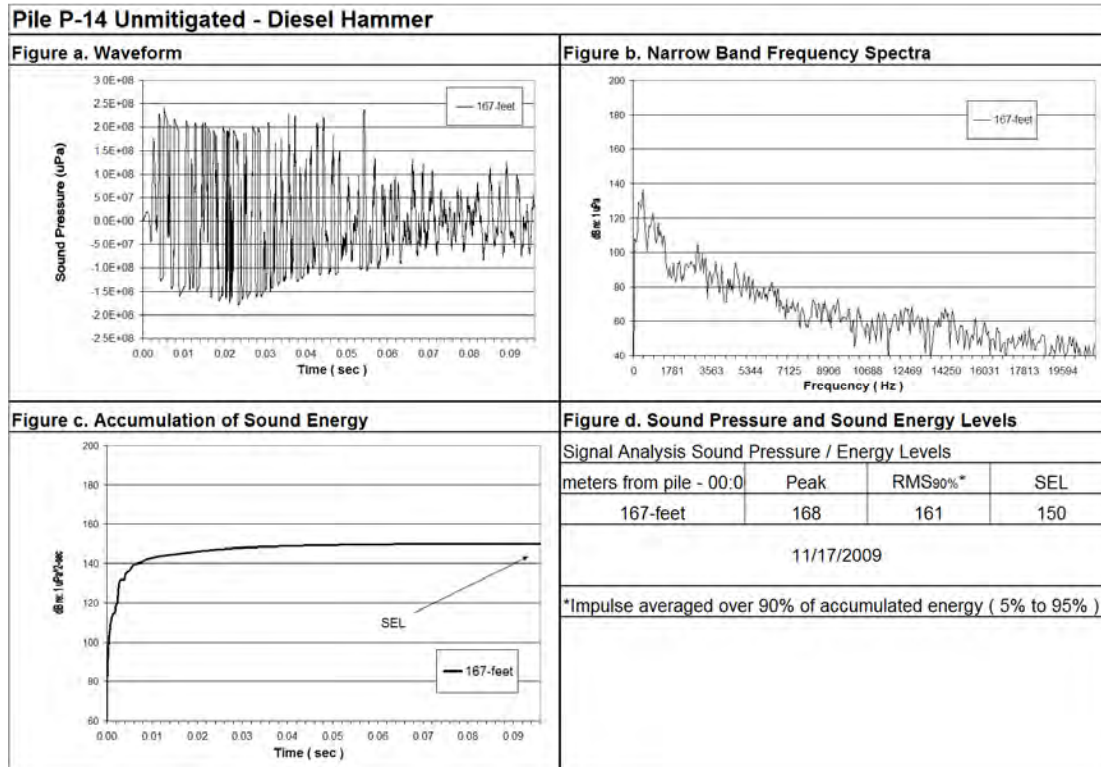

Figure 41: Waveform Analysis of Pile Number P-14 Unmitigated Sound Pressure Levels 754 meters from the pile.

PILE P-10 – MITIGATED WITH BUBBLES

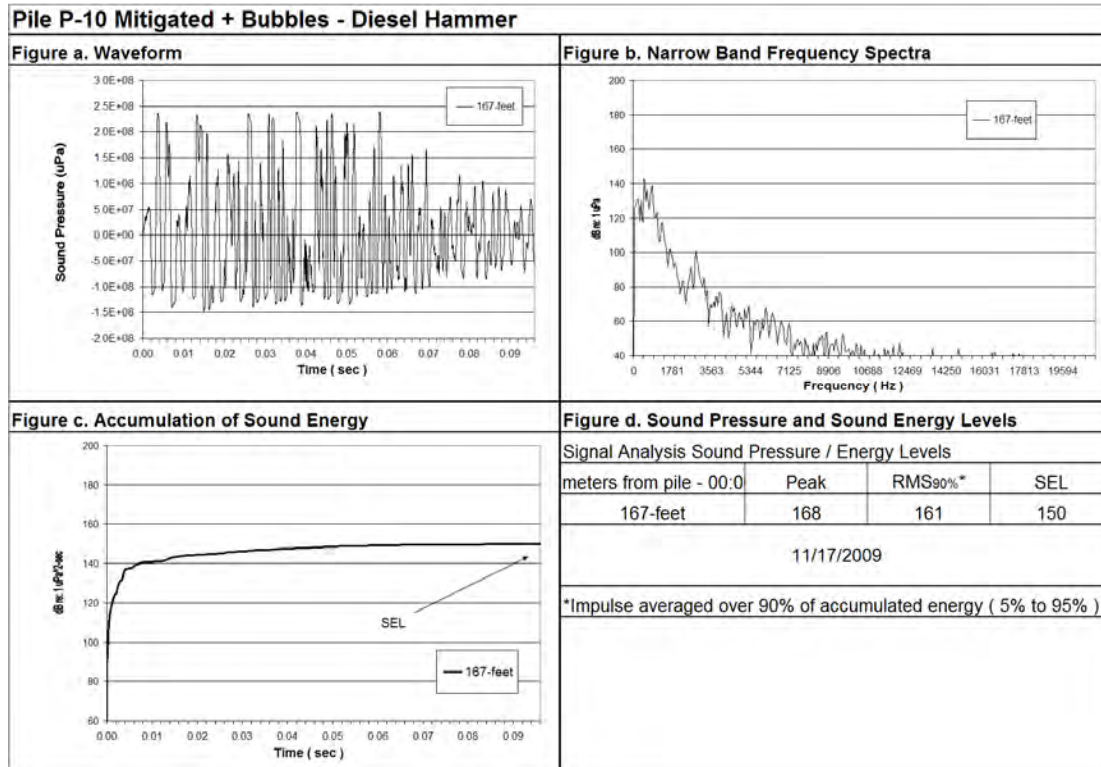

Figure 42: Waveform Analysis of Pile Number P-10 Mitigated with Bubbles Sound Pressure Levels 754 meters from the pile.

PILE P-16 – MITIGATED

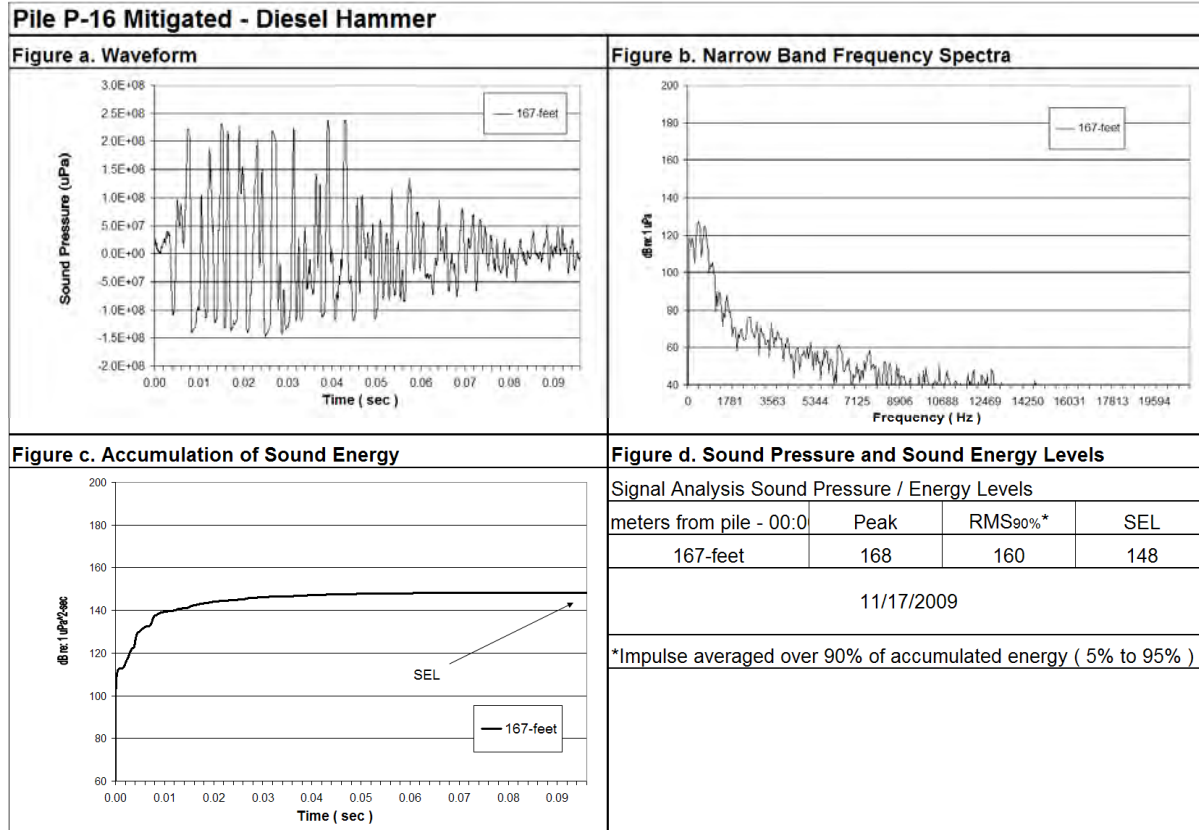

Figure 43: Waveform Analysis of Pile Number P-16 Mitigated Sound Pressure Levels 754 meters from the pile.

PILE P-16 – MITIGATED + BUBBLES

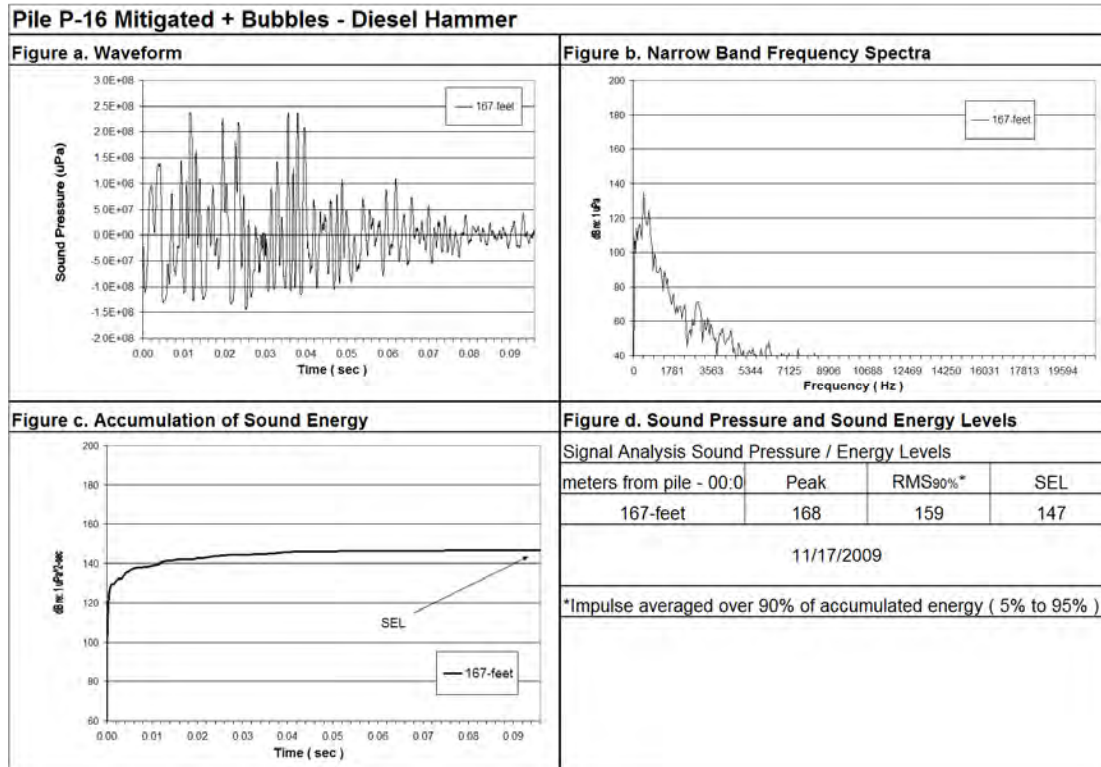

Figure 44: Waveform Analysis of Pile Number P-16 Mitigated with Bubbles Sound Pressure Levels 754 meters from the pile.

PILE P-16 – UNMITIGATED + 24 HR

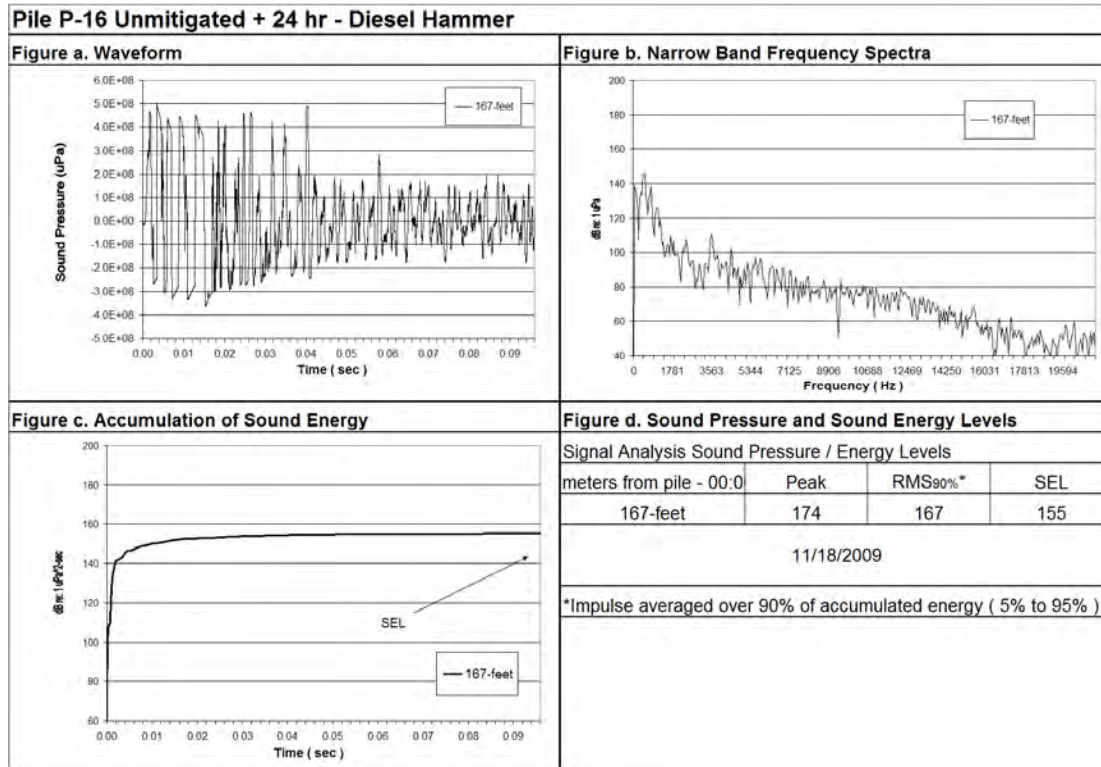

Figure 45: Waveform Analysis of Pile Number P-16 Unmitigated after setting for a 24 hour period 754 meters from the pile.

PILE P-8 – MITIGATED WITH BUBBLES

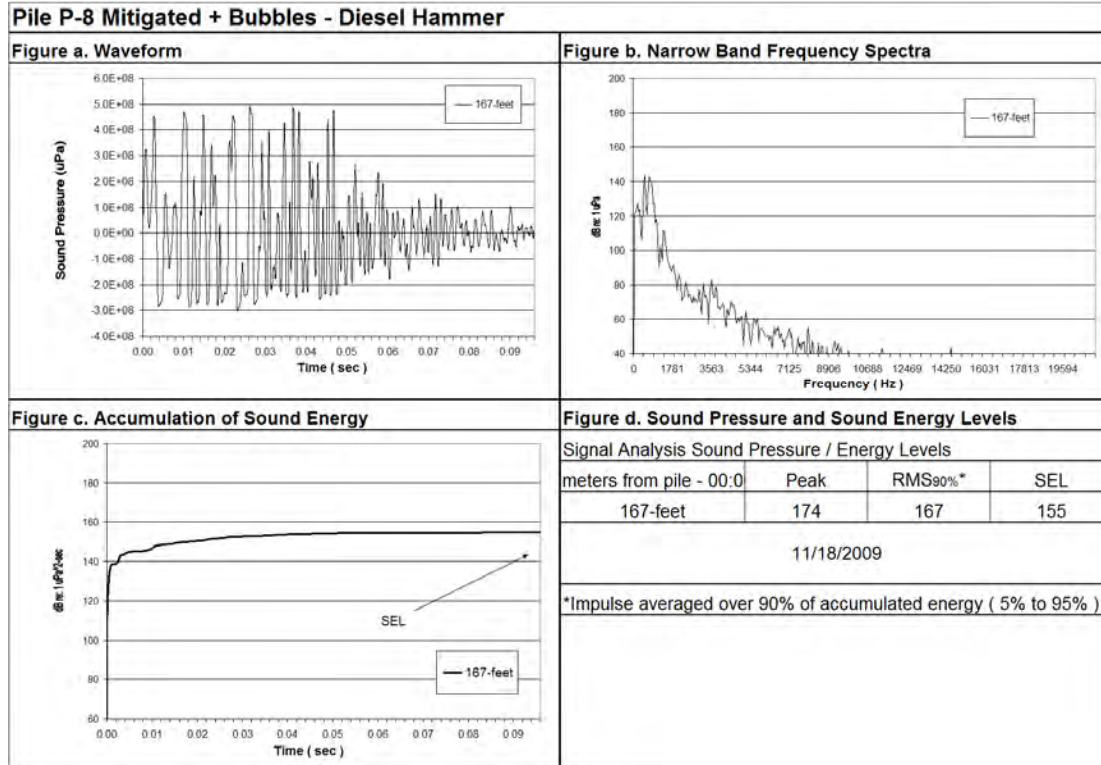

Figure 46: Waveform Analysis of Pile Number P-8 Mitigated with Bubbles 754 meters from the pile.

PILE P-8 – UNMITIGATED

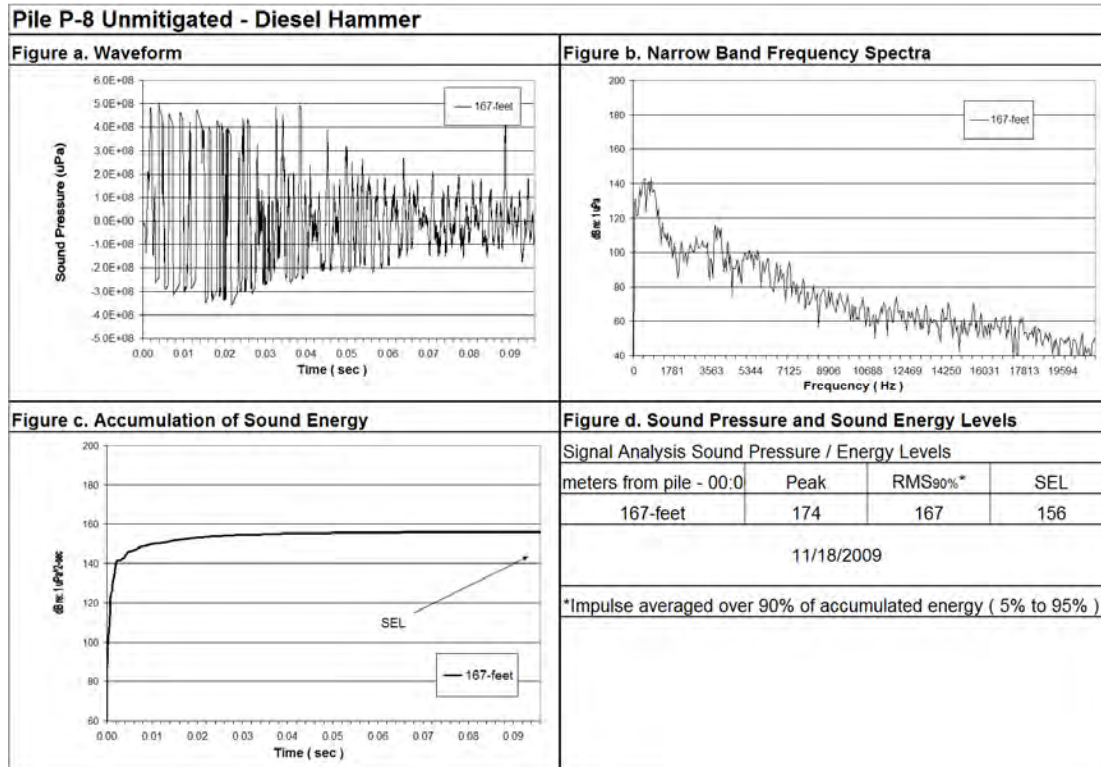

Figure 47: Waveform Analysis of Pile Number P-8 Unmitigated Sound Pressure Levels 754 meters from the pile.

APPENDIX C– PILE DRIVING LOG

Pile P-16 (left rear) 17 Nov 09

Foot #	H	BPM	BN	Remarks
1				Late turning on Saximeter
2	9.3	39	10	37' sounding at 1215.
3	9.1	39	12	
4	9.1	39	13	
5	9.2	39	15	
6	9.2	39	14	
7	9.3	39	16	Total blows: 130
8	9.5	38	17	
9	9.6	38	18	1318: End driving
			+ 4 blows	
10	10.2	37	39	Last foot delayed.

Pile P-14 (left front) 17 Nov 09

Foot #	H	BPM	BN	Remarks
1	8.8	40	15	
2	8.9	40	12	39' sounding at 1350. TNAP 41' at water line with weight on bottom.
3	9.1	39	11	
4	9.1	39	9	
5	8.9	40	11	
6	8.7	40	9	
7	9.2	39	8	
8	8.6	40	9	1422. End driving
9	8.6	40	10	
10	8.5	40	8	Total blows: 106

Pile P-8 (right rear) 17 Nov 09

Foot #	H	BPM	BN	Remarks
1	9.5'	39	23	1503. Begin driving
2	8.7'	42	20	37' sounding. TNAP 39' at water line with weight on bottom.
3	9.7'	38	20	
4	9.6'	39	18	
5	9.8'	39	26	
6	9.1'	40	23	Total blows: 196
7	9.9'	38	24	
8	10.1'	37	25	1510. End driving
6"	10.7	36	39	18 Nov at 0850
Last foot	10.8	36	64	
				40' at W/L on TNAP at 0845.

Pile P-10 (right front) 18 Nov 09

Foot #	H	BPM	BN	Remarks
1	9.5'	38		Turned Saximeter on late. 0953 Begin driving
2	9.4	39	14	14
3	9.5	38	15	15
4	9.6	38	17	17
5	9.8	38	18	18
6	9.8	38	20	20
7	9.9	38	22	22
8	10.0	37	22	22
9	10.1	37	24	24
10 Last foot	10.4'	37		0957: End driving

Final Tip:

P08	-- 76.08' EI
P10	-- 75.33' EI
P14	-- 74.25' EI
P16	-- 76.00' EI